



REHASENSE

ECO Assist

User's manual (EN)



CE

INDEX

Section	Topic	Page
1.	General Information, Intended Use and Quality Standards	3
2.	Safety Warnings and Recommendations	4
3.	General description	7
4.	Cleaning	8
5.	Transport and Storage	8
6.	Recycling and Disposal	9
7.	Maintenance and Service	9
8.	Reuse	12
9.	Warranty and Liability	13
10.	Scope of Delivery and Identification	16
11.	Product Specification	18
12.	Configurations, Controls and Display	20
13.	Device Assembly	21
	13.1 Naming of Parts	22
	13.2 Assembly – Manual Clamp and Lift	22
14.	Operating	27
15.	Accessories	34
16.	Appendices	34
	16.1 Appendix 1: Battery and Charger	35
	16.2 Appendix 2: Headlight	38
	16.3 Appendix 3: Smart Tyre Inflator	39
17.	Contact details of distributor, manufacturer	42

1. General Information, Intended Use and Quality Standards.

Thank you for choosing a **Power Add-On for manual wheelchair**. This user manual contains a description of the device and important guidelines to ensure a correct and safe usage.

Please read this manual carefully. It is especially important to read the safety requirements and to follow these.

In this User Manual, we use the following terminology: -

- Device – refers to the ECO Assist Power Add-On Device.
- User – refers to the person using the device.
- Chair – the chair that is used with the device.
- Kerb – the edging of a pavement or sidewalk. Spelt “Curb” in Canada and the USA,
- Set-up – the way the device is configured according to the Users requirements.
- Docking/Undocking – the process of connecting/disconnecting and lifting/lowering the device to the chair.
- QR – refers to Quick Release, pertaining to the clamp housing and the device proper.

The manufacturer continuously develops its devices and reserves the right to change specifications and functions of devices without notice.

If you have concerns or queries, please contact your dealer or **the manufacturer** directly. The contact data is located on the last page of this manual.

Intended use and indications for use.

Intended use: The device is intended to be used as an auxiliary drive unit for folding and rigid frame chairs. Any other use is prohibited.

Indications: The device is indicated for individuals who require power assistance in propelling the chair in a seated position. Specifically, for: -

- who have been instructed in its handling,
- can move and coordinate both hands and arms without major restrictions,
- have the physical and mental ability to operate the wheelchair and device in all possible situations.

Contra-indications: This type of device must not be used by persons with cognitive or processing limitations that would prevent them from using the device as intended.

Use by people with partial or complete flaccid paralysis must be determined by a qualified chair fitting expert with advice from a physician and/or an occupational or physical therapist.

The ability to safely control the device is essential to its use.

Chair pairing: It is important that the chair used can withstand the forces generated by clamping and driving with the device. Significant stresses may be applied to the chair beyond what it was originally designed for. Please consult with the supplier of the device before changing to chairs other than what the device was fitted to at the time of delivery. Refer to your Authorised ECO Assist Dealer for interface options for fibre composite frames.

Quality standards.

The Device has passed all necessary tests and it is in conformity with following European Standards:

ISO 14971 ; ISO 20417 ; EN 12184 ; ISO 21856 ; ISO 7176 -Part 1, 2, 3, 4, 5, 6, 8, 9, 10.

It also fulfils all CE requirements implemented by the 2006/42/EC (Machinery), 2014/35/EU (Low Voltage), 2014/30/EU (Electromagnetic Compatibility) Medical Devices Directive.

2. Safety Warnings & Recommendations.

This manual points out the most common procedures and techniques involved in the safe operation and maintenance of the device. It is important to practice and master these safe techniques until users are comfortable in manoeuvring around the frequently encountered architectural barriers.

Users and assistants must be aware that the handling and maneuverability characteristics of device are inherently different from manual wheelchairs. Handling and maneuverability differences will be most noticeable when traveling down declines (example: ramps and slopes) or over obstacles and rough terrain as this may shift the users centre of mass forward resulting in decreased stability. ALWAYS reduce speed when driving under these conditions.

REHASENSE recognizes and encourages each individual to try what works best for him/her in overcoming architectural obstacles that they may encounter. However, all warnings and cautions given in this manual MUST be followed. Techniques in this manual are a starting point for the new user and assistant with "safety" as the most important consideration for all.

It is important for the User to recognize and understand that there is a danger of personal injury from falling from the device or colliding with objects if it is not handled or set-up correctly.

Therefore, it is very important that a thorough understanding of the use and limitations of the device is reached by the User before using the device. Following are some points that are important to read and understand.

If there are any areas where the concepts are not clear, please contact your authorized The Manufacturer Dealer or The Manufacturer directly (info@rehasense.com) for further clarification.



Consult – talk to a person qualified in supplying, fitting, and servicing the device.

- Before deciding which model to choose, communicate with authorized The Manufacturer dealer – do not purchase this device from non-qualified suppliers or in the open market.
- As this is a powered device, it is important to consult with a physician and or therapist to determine if the user has the physical and mental capabilities to control the device.
- A one-to-one instruction session on handling and operating of device is included in the scope of delivery.



Read – read the User Manual.

- Make sure that this user manual is read by all persons using the device. The Manufacturer does not take any responsibility for damages and/or injuries, caused by the fact that the user manual has not been followed.
- Follow the instructions and warnings on all device labels.
- All "Attention" in UM should be carefully reviewed and understood.



Driving Environment – be aware of the conditions in which the device is used or exposed.

- All (3) wheels should ALWAYS be in contact with the floor during use. This will ensure the device is properly balanced and should avoid incidents.
- The device must only be used on a stable surface.
- Do not use device in escalators or moving walkways.

- It is not recommended to use the device on sand, in mud or in extreme weather conditions unless the model indicates that this is an approved use environment.
- The temperature range for use is between -25 degrees Celsius and plus 50 degrees Celsius.
- The device is not recommended to be exposed to strong electric fields, excessive heat, or moisture.
- The device's operation might interfere with other electrical devices.
- Please never exceed the technical limits mentioned in the UM.



Driving training, obstacles, and slopes.

- We recommend having driving training when you receive the ECO Assist, to become familiar with the device and its limitations.
- The device can climb obstacles with a maximum height of 5 cm – do not exceed this obstacle height.
- On inclines, it may be necessary to lean forward to move the center of mass (or gravity) closer to the drive wheels to maintain traction on the drive wheel.
- When device is attached to the chair, it is regarded as a three-wheel vehicle. Reduce speed when turning, going across kerbs, cambers, and bumps to avoid tipping over.
- Always be mindful of your speed when driving on public roads or footpaths. Please observe and follow the local road traffic regulations in the country of use,
- Please practice driving on the level ground before attempting sloped surfaces, to become familiar with the device and its limitations.
- When driving, and after releasing the throttle, please be aware that the device will not stop automatically. The handbrakes must be applied to bring the device to a full stop.
- Unless the brakes are applied, there is the risk of the device moving on a sloping surface. Always apply the brakes when not using the throttle.
- Do not climb slopes (up to 3 degrees) in the "Walk mode" only. We recommend the lowest speed mode (Mode 1) for climbing.
- Ensure a fully charged battery before attempting a trip that has sloping ground.



Use and Speed.

- Always drive within your ability to control the device to a safe stop. Using/driving the device at uncontrollable speeds is the user's responsibility and the manufacturer/dealer will deny/refuse any responsibility of accidents or damages to third party,
- Speed limits are determined according to the local traffic regulations. These limits will be programmed at the time of manufacture and will be controlled in steps to reach the maximum permitted speed as determined by the traffic authorities. If a lower limit is required than the local regulations permit, then this can be programmed by the authorised Rehasense ECO Assist representative in the delivery location.



Attention – key points.

- The device must not be loaded with more than 110 kg,

- The drive wheel of ECO Assist is free to move even when switched off. Please do not reach into the rotating wheel as it may cause serious injuries. Make sure that the brakes are also locked during standstill and transport.
- Use the device only in good technical condition and only for the purpose it is intended for,
- If defects or errors are detected bring the device to a gradual stop (if in use) and immediately contact your dealer,
- Do not remove by yourself any parts or make any constructive changes to the device. It may influence device's stability and performance,
- Avoid skin burns during usage of the device in direct sunlight. Various parts of the device might become hot,
- Attaching any accessory which is not from the optional accessories list is not allowed,
- Before using the device, please carefully check tyre air pressure, battery residual power, whether the horn works, the brakes are functioning and all elements are secured correctly,
- The device is not used for any purpose of transferring goods, carrying additional people in the chair or use during sporting activities,
- When driving on public roads or footpaths, please observe and follow the local road traffic regulations in the country of use,
- As lithium-ion cells are used in the battery pack, transportation will be subject to all regulations for portable power cells. Please consult with authorities or your travel company (e.g., railway, bus company, shipping company) to find the best way to transport your device's batteries.

WARNING!

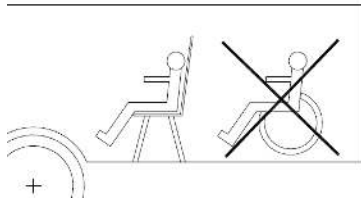

The device and chair are not designed as a seating option for a user in moving vehicles (like e.g., buses, trains, metro, airplanes etc.).

It is forbidden to seat on the device in moving vehicle. The device and chair should be safely stowed and secured for the time of transportation.

The user should be safely transferred and seated in a prompt seating system included in the vehicle. It is a great risk of serious incident, injuries, and property damage to not follow above rule.

The design of the device because of its functions includes many moving elements, slots, holes, and gaps between device's parts.

There is a risk of body part trapping during folding, unfolding, and adjusting different elements of the device. It specially concerns fingers or hands.

It is also possible to have a finger cut by moving parts of the device. Always be careful when you adjust or set-up a chair to not get your body parts squeezed and injured.



IF ANY SERIOUS INCIDENT OCCURES IN RELATION TO THE DEVICE, PLEASE CONTACT YOUR DEALER OR REHA-SENSE DIRECTLY (contact details are at the end of the user manual). These immediate actions should be taken according to the requirements of Regulation of the European Parliament and of the EU Council 2017/745 on medical devices of April 5, 2017.

3. General Description of the Device.

The device is an electrically powered towing device that is attached to a manual chair, converting it into a power-assisted chair.

The range and performance of device greatly increases the chair users' daily travel range under all but the most conditions. This increased freedom of movement may facilitate the users' life and broaden their activity range, which fundamentally enhances the users' independence and confidence. All metal components on ECO are protected against corrosion.

Elements of the Device.

ECO Assist is a system where most elements of the devices are configured according to the Users requirements for economic purpose.

Including elements are:

- The frames, lights, display, warning system and battery,
- The wheels, handlebar set-up and the docking system.

Wheel Diameter:

- 12" Wheel (City): low weight, battery consumption, torque (35 Nm) and motor power. Most maneuverable. Suitable for indoors and tarmac road. Best at low to middle speed range.

Docking set-up:

- Manual Clamp and Lift: Users have enough strength to perform the lift and clamp operation without assistance,

Handlebar control set-up:

- Standard throttle and brake handle: Users who have enough hand control and strength operate the speed and brake control without assistance.



Attention! It is very important that User's strength and coordination are tested before selecting set-up options and test driving! See Section 2 "Safety Warnings and Recommendations" (above).



Figure 1. Main Elements for the Device

4. Cleaning

Attention! Water penetration can destroy the electrical system, motor, and the battery pack. The Manufacturer shall not be liable for damage caused by water inside the device. Please pay attention that water damage is not covered by our warranty.

Cleaning

- Do not clean the individual components of the device under running water or with a high-pressure cleaner,
- Always ensure that no liquid or moisture enters the wheel hub and the battery pack,
- Whenever you clean components or the battery pack, use a dry or slightly damp cloth,
- Never use scouring pads, abrasive detergents, or aggressive chemicals to clean the components.
- Do not clean with solvents such as benzene or thinner. This can damage paint and plastic parts.
- Chlorine-based cleaners are not allowed.
- Do not clean with cleaners with corrosive to metal substances or mixtures.
- For disinfection, remove a battery, then disinfection by spraying or wiping with a tested and approved product is allowed. A list of current permitted disinfectants is available from the Robert Koch Institute at <http://www.rki.de>.

5. Transport and Storage

Transport

- Please keep the original packing box for later use if the device is to be transported for service or other reasons.

Handling and Lifting

- Please observe safe lifting practices when lifting the device or its individual elements,
- Remove the battery for easier handling and lifting.
- When lifting, remove all detachable elements and always get the support of second person.
- Do not lift or handle by gripping the basket or cables.
- Always use the support legs when cleaning or handling the device.

Storing and Commissioning

- Store in a dry room, out of direct sunlight,
- Remove the battery pack after fully charging and wrap it in film,
- Also protect the device with film to keep moisture out,
- Ensure that unauthorized persons (especially children) do not have unsupervised access to this room.

Recommissioning

- Check whether maintenance is required before recommissioning and arrange this if necessary,
- The chair, the device and the battery pack must be cleaned prior to recommissioning,

- There must not be any metallic particles on the plug on the charger and on the charger socket on the battery pack.

6. Recycling and Disposal

Support sustainability by adhering to local regulations for recycling and disposal of the device once its serviceable life is ended.

- The device is labelled in accordance with European Directive 2012/19/EU (WEEE Directive) with a "crossed-out rubbish bin" symbol, reminding you that it must be recycled,
- All materials may be recycled once the device has finished its serviceable life,
- Be sure to dispose of the device correctly by returning to your Dealer or take to a recycling Centre.

 Attention - Do not add to landfill as batteries and other components may leak substances that are hazardous to the environment.

7. Maintenance & Service.

Maintenance

Despite the solid construction and usage of resistant materials, the device is subject to wear. It is therefore recommended to have a professional checking the device at regular intervals – usually at 2 years since purchase or earlier if there is any doubt about the device's performance.

This guideline value of 2 years may vary with the device's respective degree of utilization and the behaviour of the user. Checking the degree of utilization and the user behaviour is the responsibility of the operator.

 **Attention!** Please also consider the condition of the chair! The maintenance of the chair is equally important as that of the device. Manufacturer's recommendations may not consider the use of the chair with the device, so please contact your chair supplier to ask about maintenance when using a device!

Parts (shown below) also include "generic" care instructions for the chair. These should be considered along with the chair manufacturer's own care instructions, which should be regularly inspected.

NOTE: Gradual deterioration in performance because the battery has been left in a discharged state, left in cold conditions for an extended period of time, or worn out through heavy use is not covered under the guarantee.

Part name	Control type	Control frequency
	Device	
Battery and Charger	Ensure contact points are clean on the battery and its housing by wiping with a dry cloth. Also check that the plug and battery socket for charging are clear of any dirt or metal particles.	Whenever recharging the battery.
Brake Levers	Brake cables may stretch over time. These can be adjusted by loosening the lock nut and turning the adjuster next to the brake lever housing. Retighten after adjusting.	As indicated through use.
Handlebars	Check tightness of all fasteners on the handles bars to ensure stability of parts. Only use the tools supplied.	Depending on use, and/or monthly.
Lights and Horn	Normal function check.	Before driving each time.
Disc Brake Assembly	Clean dirt off the Brake Disc and check for excessive wear such as gouging or deep grooves.	Whenever the braking performance feels diminished or monthly.
Clamping Mechanism to Chair Frame	Check adjustments if slipping or excessive markings on the tube are noticed or manual clamping becomes harder or easier than when first delivered.	As indicated.
Clamping Mechanism to Device Frame	Check the tension and adjust to ensure a firm grip on the Width Adjusting Rods.	As indicated, especially when changing to different chairs.
	Common to both Chair and Device	
Pneumatic Tyres	Tyre pressure (check manufacturers specifications), condition of tread and tyres. One should take care, to keep the pressure in all tyres on the same level. Harder tyres provide better maneuverability and easiness of driving but reduce comfort on bumpy surfaces.	At least once a week; see manufacturers "Specifications".
Spokes	Loose spokes can cause deformation of the rear wheels. Contact your dealer or local bicycle service to manage the problem of loose spokes.	If the problem occurs.
	Chair only	
Push Rims	Excessively scratched push rims ought to be exchanged because they can wound the user's hands while riding the device.	If necessary
Brakes	The braking force depends on the tyre pressure. The efficiency of brake operation can be also affected with dirt accumulated on tyres. Keep the brakes clean wiping them with a damp cloth to remove dirt.	At least once a month, depending on usage conditions.
Frame and Rear Axle Mount	Depending on the patterns of use and the possibility of abnormal use and wear, check all frame welds, axles, back canes, and seat mounts for evidence of cracking or other damage. Attention! If noticed, do not use until rectified.	At least once a month, depending on usage conditions.

Turning wheels	The area between the fork and the front wheel should be kept clean, because dirt accumulating there can cause faster wear of caster bearings. To do so, one should disassemble the front caster by disassembling it from the fork, to remove all dirt, and then preserve the metal elements of the wheel (i.e., to apply technical grease).	The maintenance ought to be made once a month or more often depending on usual surface type & conditions.
Detachable elements	Check the condition of detachable elements of the chair; if screws are loose, they should be tightened.	In case of intensive exploitation of the chair and device the inspection should be carried out once a month.

Service

Introduction

Regular service is important for the longevity of the device, which, along with repairs, must be carried out by authorized dealers or the Manufacturer.

For authorized repairs and service, please contact the supplying dealer or contact the Manufacturer directly.

 **WARNING!** Unauthorized repairs will cause loss of warranty. The Manufacturer does not guarantee proper functioning of the device if it has been repaired by unauthorized service and/or not using original spare parts.

Regular Service will be scheduled at the time of purchase with the dealer.

One Month Check.

- After the first month of use it is recommended that the device be returned to the dealer for an overall check,
- Any adjustments to the fitting can be made along with an overall check of all fasteners and adjustable elements.

24-Month Service.

- Apart from regular maintenance by the owner, a 24-month full Maintenance Service is required,
- This will include check for all worn parts and replacement. The Pre-Delivery check will be repeated, and the chair and device adjusted to the User's needs,
- The battery condition and power output of the drive wheel will be checked then also.

Failure

In case of any device failure, we recommend you immediately contact the dealer.

The Display has some diagnostic functions – you may be required to relay this information to the Service Technician. if you are not able to rectify the issue directly.

No.	Error code	Function (Grouping)	Error description	Solution
1	Error 03	No throttle response	Brakes are locked on - power circuit interrupted	Release the brake to re-open power circuit.
2	Error 05		Throttle broken	1. Check the throttle cable 2. Change throttle 3. Contact dealer
3	Error 04	Cannot change gear to "0" setting	Throttle partly engaged.	Ensure the throttle is fully released. Clean and lubricate if dirty.
4	Error 08	Motor issue	Motor hall sensor broken	1. Check motor cable to see if it is well connected. 2. Disconnect the motor cable, find a new device in same model, reconnect the cable with motor wheel in new device. If error still exist, then the error comes from controller. Change the controller. If not, then change the motor Wheel. 3. Contact dealer
5	Error 11		Motor temperature protection value	
6	Error 10	Controller issue	Controller temperature protection value	1. Allow controller to cool down
				2. Still not work, change the controller
				3. Contact the dealer
7	Error 21	Speed Sensor issue	Speed sensor broken	Contact dealer

 **Attention!** When an error disappears, the node sends "0x00" to clear the error. When there is no error, the controller and the derailleur would send "0x00" once every 500ms, which indicates that the part is working regularly.

 **Attention!** Please do not carry out repairs in dangerous areas (for example a busy road). For your own safety, please leave the danger area. Since the ECO Assist has a free-moving drive wheel, you can maneuver yourself out of the danger zone using the push rims on your wheelchair.

 **Attention!** If using a transport service to send the device for repair of service, please use the original packing for all transport actions. If not available, ensure that the packing used is sufficient to protect the device. If you are in doubt, please contact the dealer for packing instructions before sending.

 **WARNING!** The Manufacturer does not take responsibility for transport damages of the device or components caused by improper packing.

8. Reuse

ECO Assist may be used by another person if required. However, before transferring it to another user, it must have technical inspection in accordance with the chapter "MAINTENANCE" by authorized specialist dealer. The function of the device must be set up for the new Users abilities and needs. All functional areas must be checked – especially the handlebar controls.

In addition to the cleaning chapter the device should be disinfected using the generally available disinfectants without chlorine and phenol. The manufacturer is not responsible for the damage caused by wrong usage of disinfectants.

9. Warranty and Liability

ECO Assist is a Powered Drive System designed to connect onto the front frame of manual wheelchairs.

IMPORTANT SAFETY INSTRUCTIONS

The information below is essential for the safe setup and use of the ECO Assist system.

To maximize user safety when using a ECO Assist device with a wheelchair, the following elements are essential to minimizing risk:

- Reading the User Manual
- Correct fitting and setup by a trained Product Specialist
- Training for correct use by a suitably qualified product specialist
- Timely maintenance being completed within required service schedule intervals

Warranty

ECO Assist comes with a 24-month warranty for all parts (except for the battery) against manufacturer defect or faulty materials. The battery comes with a 12-month warranty against manufacturer defect or faulty materials.

It is a back to base warranty and is managed via the supply source where the system was purchased.

It is a limited liability warranty and does not cover damage to third-party wheelchairs.

Power Drive Systems and Wheelchair Compatibility

Wheelchairs are designed to safety standards that define how stable and how durable they must be to safely perform during a typical usage lifecycle (ISO 7176:1-20). This standard is written to simulate typical use with reference to manual propulsion and is tested to simulate a lifespan covering 350 km of travel*.

Using a wheelchair with a Power Drive System may expose it to wear and tear far in excess of the typical wheelchair design lifecycle. Regular use with a Power Drive System over unsealed terrain and over extended distances may accelerate wear of critical wheelchair parts.

It is important that the user contacts their wheelchair manufacturer/supplier to confirm the wheelchair warranty conditions and service requirements if being used with a ECO Assist Powered Drive System.

Compatibility and Connection Table: Main Side or Anterior Wheelchair Frame Tube Connection Parameters	
Round Tube Diameter	Min: 19.0 mm - Max: 40 mm
Minimum Wall Thickness	1.2 mm
Tube Materials	High grade Aluminium alloy - 6061-T6 or 7005-T6
	Titanium alloy (TiLite)
Clamping points width range	240 mm - 540 mm (according to adaptor chosen)
Straight Tube Section for Clamping	Minimum 50 mm, without bends.
Clamping Force	2000 N
Irregular or composite profiles	Asymmetric or Composite Fibres - interface adaptors needed*

* Contact the authorised distributor for ECO Assist to find out which composite frames or irregular profiles can be fitted with adaptors.

How To Extend Wheelchair Lifespan When Using ECO Assist Power Drive Systems.

- Connection
 - Ensure the clamp interface between the ECO Assist and the wheelchair frame is correctly fitted to the specific profile/dimensions
 - Check the Compatibility and Connection Table (CCT) to confirm that your wheelchair can be used safely with ECO Assist and reference the CCT for critical dimensions and clamp pressure
 - CCT shows range of frame tube diameter, wall thickness and material that may be fitted with the device.
- Frame Material
 - Aluminium alloy frames (high grade) 6000 and 7000 series alloy tubes may be paired to the device.
 - Composite fibres frames, such as carbon fibre, are not suggested for use with ECO Assist due to the inherent weakness in composites under compressive forces.
- Frame Shape
 - Round Tubing – see the CCT
 - Non-round or asymmetric profile shapes - please enquire with the authorised ECO Assist supplier.
- Clamping Tightness/Force
 - The force required to maintain a secure connection is shown in the CCT.
- Rear Wheel Selection for Shock Absorption
 - Tyres – it is recommended to use large profile tyres - the bigger the tyre, the greater the shock absorbing capacity.
 - Spokes – wheels with stainless steel spokes are suggested due to increased durability.
- Maintenance
 - Frame inspection – look for any wear, bending, indentation or cracks on the frame. If any are detected, please inform your dealer immediately and have the chair and ECO Assist inspected.
 - Rear wheels – check tyre pressure, quick release axle function, wheel symmetry, spoke tightness and rim condition.
 - Seat canvas – look for general wear and any areas that might have started to fray or are broken.
 - Other components – check for any loose hardware or parts that may require adjustment. If necessary, use Loctite Blue 243 to ensure fasteners are appropriately secured.

Pairing With Wheelchairs

ECO Wheelchairs

- These models are developed based on our knowledge of chair design and observations of durability requirements during the development of ECO Assist.
- Features include: -
 - Frame Reinforcement
 - Rear Axle Camber
 - Rigid Back Canes

- Safety Belt
- Rear Wheels with stainless steel spokes and high-profile tyres
- Third Party Wheelchairs
 - It is recommended that only chairs that have passed ISO 7176, by an independent testing authority, be paired to power add-on devices,
 - The wheelchairs paired must meet the criteria for frame tubing, especially at clamp interface. Please see the CCT for frame requirements,
 - The device and chair coupling must be performed by an authorised ECO Assist distributor.

The warranty is limited to replacement due to defects in parts or workmanship. REHASENSE shall not be required to replace any units that malfunction or are damaged due to abuse, accidents, alteration, misuse, neglect, maintenance by someone other than REHASENSE or sales partner, or failure to operate the instrument in accordance with this user manual.

Further, REHASENSE assumes no liability for malfunction of or damage to REHASENSE products caused using wheelchair, charger, or accessories other than the appropriate products recommended in this user manual.

REHASENSE has no knowledge of the performance of the ECO Assist when used with any wheelchairs or chargers other than recommended in this user manual, and therefore does not warrant the performance of the ECO Assist when used with any wheelchair or charger other than recommended in this user manual is altered or modified in any manner. REHASENSE makes no warranty regarding the performance of the ECO Assist when used with any wheelchair or charger other than recommended in this user manual.

REHASENSE MAKES NO OTHER EXPRESS WARRANTY FOR THIS PRODUCT. THE OPTION OF REPLACEMENT, DESCRIBED ABOVE, IS THE ONLY OBLIGATION OF REHASENSE UNDER THIS WARRANTY. IN NO EVENT SHALL REHASENSE BE LIABLE FOR INDIRECT, SPECIAL OR CONSEQUENTIAL DAMAGES, EVEN IF REHASENSE HAS BEEN ADVISED OF THE POSSIBILITY OF SUCH DAMAGES.

- Warranty - If any defect or damage occurs, the User should immediately inform the Dealer or contact the supplier directly.
- Warranty for defects - The Manufacturer guarantees that the device is free of defects at the time of delivery. This warranty expires 24 months after the date of delivery of the device,
- During that period, all material, or parts defects (excluding the Battery), caused by manufacturing faults or usage of improper materials during construction will be repaired or replaced free of charge.
- Battery Exception: The Battery has a replacement guarantee of 12 months from the time of purchase. This is because the condition and performance of the battery will depend on the recharging history.

The Warranty does not include:

- Devices whose serial numbers have been tampered with or removed.
- Worn parts such as tyres, grips, handles, levers, and spokes.
- Defects caused by normal wear, incorrect handling including non-compliance with the instructions in this operating manual, accidents, reckless damage, damage caused by fire, water, force majeure, and other events that are outside the control of the Manufacturer.
- Parts that may need to be serviced or replaced as due to normal wear and tear as part of normal use (e.g., tyre change).

- Device inspection without detection of a fault or defect.
- All mechanical defects and damages caused by improper use or usage not intended by manufacturer are not covered by warranty.
- Unauthorized changes and modifications of the device will cause loss of warranty.

Range of responsibility - This Warranty does not cover.

- transport cost,
- cover personal injury or other damages eventually related to a malfunction of this device,
- damage caused by the inability to use the device,
- damages caused as the result of inappropriate or incorrect understanding of this user's manual,

Modifications - If the device has any unauthorized modifications, then the Warranty is null and void. If you have any questions or doubts concerning modifications, please contact the Manufacturer before you take any action.

Liability - The Manufacturer shall not be liable for the safety of the device, if:

- The device is incorrectly handled.
- The device is not serviced at the prescribed two-year intervals by an authorized specialist dealer or the Manufacturer.
- The device is operated in contravention to the instructions in this operating manual.
- The device is operated with insufficient battery charge.
- The device is repaired or modified by a person not authorized to carry out such work.
- Third-party parts are attached to the device.
- Parts of the device have been removed.

10. Scope of Delivery and Identification

Scope of Delivery

The Device is delivered partially disassembled and requires setting up and adjusting after unpacking. This should be done by an authorized dealer.

Please check the contents of the box before proceeding to Assembly. Each delivery includes these items: -

- Main frame, handlebar assembly and drive wheel – assembled.
- Manual Clamp
- Battery
- Battery Charger
- User Manual

Optional Accessories that may be included: -

- Compact Smart Tyre Inflator
- Taillight

 **Attention!** If possible, please keep the original packing in case it needs to be transported to the Dealer or Manufacturer. This is also useful in the event of long-distance travel.

Packaging Instruction

Please keep all original packaging materials – these may be needed if the device must be shipped for service or repair.

Identification

The Label located on the side of the main frame has important information about the device.

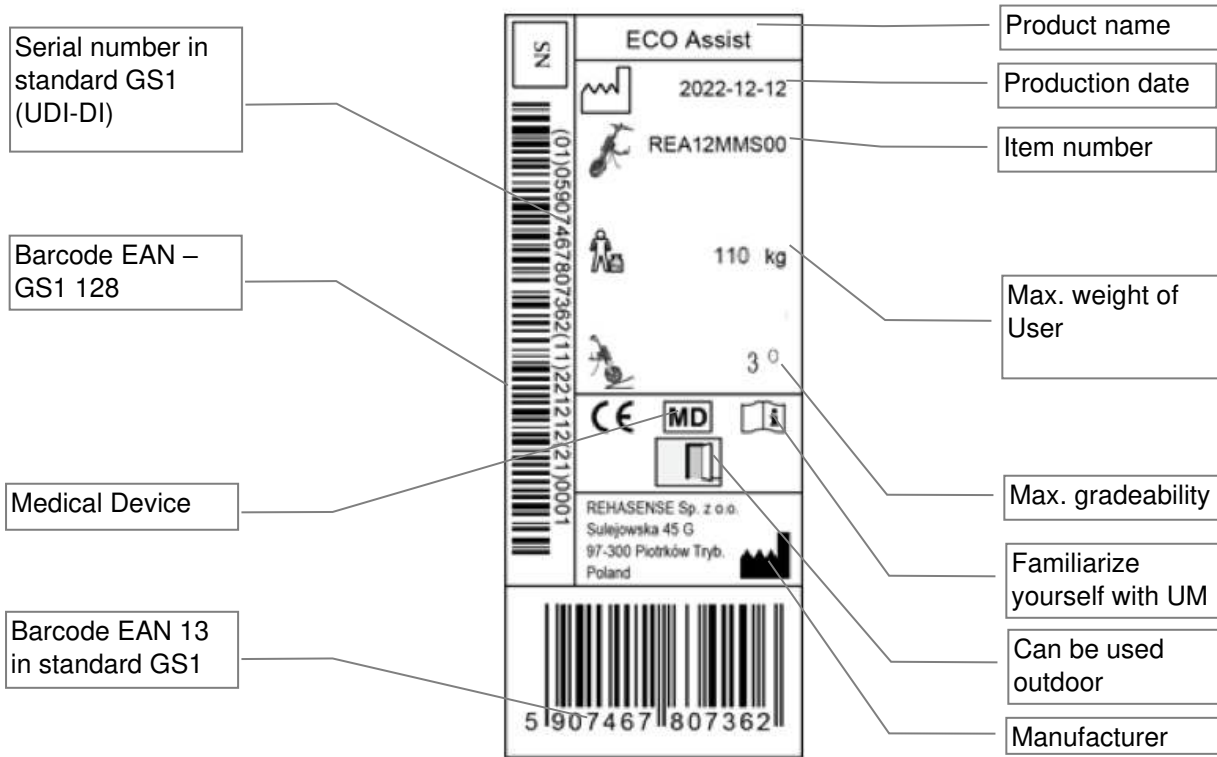

Figure 2. Label

Type - The Type describes key elements of the device. The codes for each of the ten places in the Type is described below: -

Place 1 - The Manufacturer – "R" for Rehasense

Place 2 – The Family – "E" for ECO

Place 3 – the Style. "A" for Assist

Places 4 and 5 – the Wheel Diameter. "12".

Places 6 and 7 - Docking. "MM" Manual Lift/Clamp;

Place 8 - Handlebar Control. "S" Standard; "T" Tetra

Place 9 and 10 – Tyre reference. "01" for Standard; "00" for Fat Tyres (over dimensioned tyres)

Item no.	Item description:	Model name	Clamping	Lifting	Wheel diameter
REA12MMS00	ECO Assist / MANUAL CLAMP & LIFT / NORMAL HANDLES	Assist	Manual	Manual	12"

Figure 3. Model Decoder -Types and Descriptions.

11. Product Specifications

Element	ECO Assist 12"
Overall L*W*H: (mm)	800 x 490 x 810
Packing L*W*H: (mm)	1110 x 600 x 300
Max. weight of person: (kg)	110
Max. overall weight:(kg)	125,5
Net Weight (without battery, clamping mechanism, support leg and central locking mechanism): (kg)	9.4
Battery Weight: (kg)	2
Total weight: (kg)	15.5
Motor Power: (W)	350
Motor max input power (W)	900
Motor MAX Torque(N.M)	45
Motor Voltage: (V)	48
Battery Capacity:(Ah)	5.8
Battery Rated Energy: (Wh)	278
Battery: (mm) (LxWxH)	320 x 88 x 87
Battery Charger	Standard
Charge time: (Hour)	5
Docking - Auto/Manual	Manual
Disc and "e" Brakes	Standard
Parking Brake	Standard
Turning Radius:(cm)	100
Climbing capability (dg)	3
Step climbing height (mm)	50
Range On flat terrain: (km)	30
Max Speed: (km/h)	15
Modes: in range (km/h)	3
Reverse Gear	Yes
Cruise Control	Yes
Walking Mode	Yes
Tetra Function	Option
Frame Material	Steel & Aluminum
Tyre: (Inches)	12.5*2.25 (57-203)
Rim	24 x 203
Rec. Tyre Pressure:(Bar)	2.8
Bell or Horn	Horn
Front Light	Yes

Figure 4. Specifications

⚠ Attention!

- Max speed is only for special orders of customers (users).
- Speed mode 1-3 are for each product.
- Speed limits are determined according to the local traffic regulations. These limits will be programmed at the time of manufacture and will be controlled in steps to reach the maximum permitted speed as determined by the traffic authorities. If a lower limit is required than the local regulations permit, then this can be programmed by the authorized Rehasense ECO representative in the delivery location.

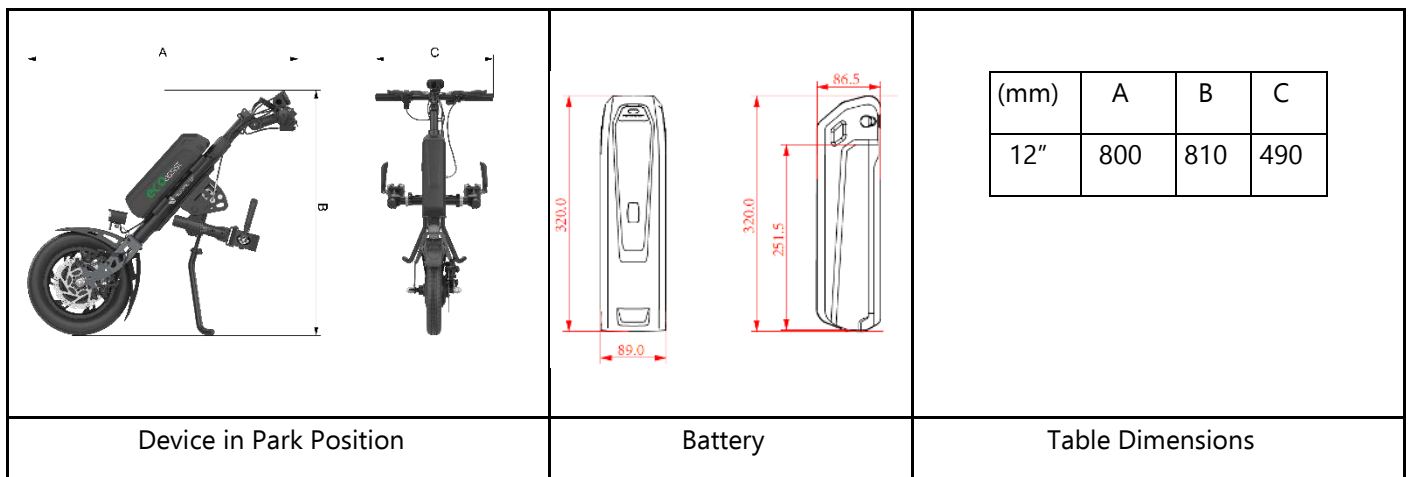

Figure 5. Device and Battery Dimensions

Dia.	Tread Pattern	Description
12"		Brand: CHAOYANG Size: 12 1/2 x 2 1/4 ETRTO: 52-203 Pattern: H-5 Air Pressure: 40 P.S.I / 2.8 Bar Car Valve

Figure 6. Tyre Specifications

Corrosion protection

Component	Used material	Surface treatment	Care
Front fork	Steel	KTL + powder coating	Please use only a slightly damp cloth and standard household cleaners for cleaning. Please repeat in case of heavy soiling
Handle tube	Aluminium alloy	anodizing	
All bolts	steel and stainless steel	dacromat, galvanizing, untreated	
All screws	same as point 4		
All washers	steel	galvanizing	
All nuts	steel and stainless steel	dacromat, galvanizing, untreated	
Support legs	Stainless steel and aluminium alloy	untreated and anodizing	
Center bracket	Aluminium alloy	anodizing	
Side bracket	stainless steel	polishing	
Manual clamping	aluminium alloy	anodizing	
Bag support bracket	aluminium alloy	anodizing	
Mug guard	plastic and steel	galvanizing	

12. Configurations, Controls and Display.

Description

The ECO Assist has the defined configuration for economic purpose that suit the Users situation.

It is with manual docking, standard handlebar driving and double hand braking control systems.

 **Attention!** Any other configurations required can only be changed by the Manufacturer or authorized dealers with approved components.

Configuration

The needs of the User determine the set-up of the device and controls. The set-up offering the most assistance is for Users with restricted neuro-muscular abilities.

Assistance is in this forms.

- Only manual docking– Clamping/Unclamping & Lifting/Lowering
- Driving and Braking – Standard controls to support these actions with double hand braking.

The Standard Handlebars is with the gripping method for the hand controls for throttle (right hand) and brake (left and right hand).

 **Attention!** The ability of the User to control the key functions of speed control and braking will determine if it is safe to use or not.

Controls

The controls are switches, buttons or levers that are used to operate the device. They describe the 5 main “systems” of the device:

- Power – Battery and Device
- Safety – Lighting and Warning
- Docking – Clamping/Unclamping & Lifting/Lowering
- Driving – Accelerating/Decelerating
- Braking – Slowing down & Parking.

No	Systems	Name	Function	Std.
1	Power	Battery	Power's device	x
2		Battery Lock	Key lock for Battery	x
3		Battery Power Button	Starts battery & charge level	x
4		Device Power Button	Device "on" or "off" button	x
5		Traction Control Switch	prevents wheelspin	x
6	Safety	Head Light Switch	Selects 3 headlight settings	x
7		Horn Button	Audible warning button	x
8	Docking	Manual Lift Control Lever	Control 2 Lift Positions	x
9	Drive	Screen	Driver Display	x
10		Direction Switch	Forward or Reverse	x
11		Throttle Handle	Control's acceleration	x
12		Cruise Button	Cruise control on and off	x
13		Speed Mode Button - Up	Selects higher speed modes	x
14		Speed Mode Button - Down	Selects higher speed modes	x
15	Braking	Brake Handle Lever	Control braking during driving	x
16		Parking Brake Catch	Controls stationary braking	x

Figure 7. ECO Device Controls

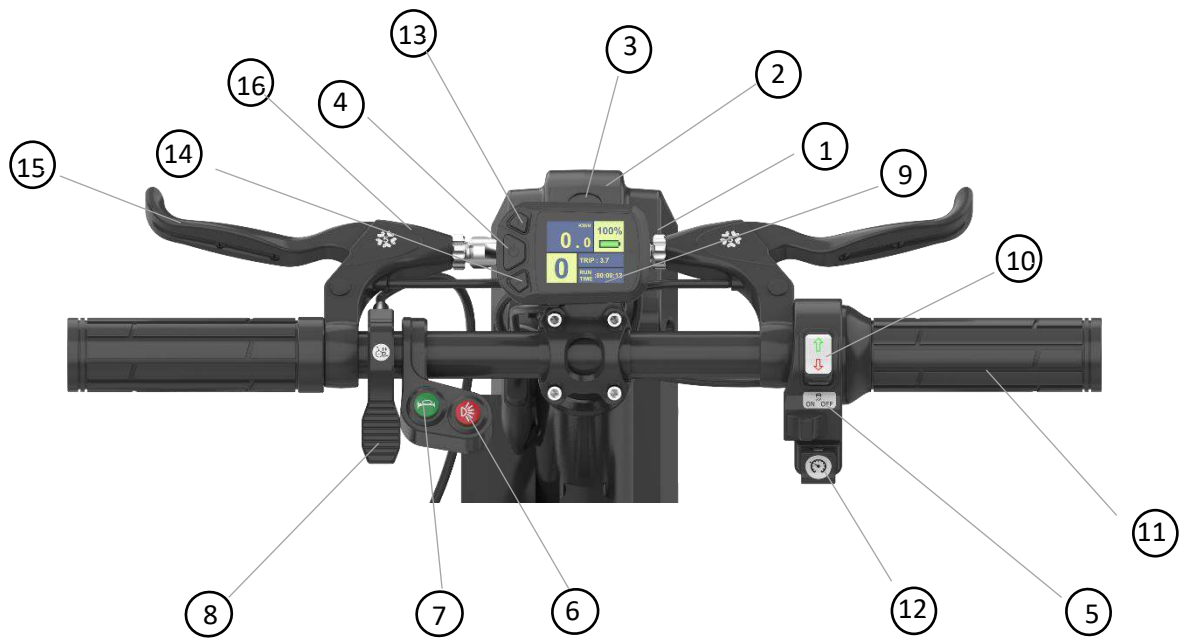

Figure 8. Standard Controls

Display



Figure 9. Display Functions

13. Device Assembly

Introduction

This section describes: -

- the **assembly** according to the clamping and lifting configuration chosen,
- the general **operation**, with exceptions where the configurations vary.

13.1 Naming of Parts.

Description

This section shows and names all major assemblies and key functional parts in the device for Manual Docking Assemblies.



Figure 10. Manual Clamp and Width Adjustment Assemblies

13.2 Assembly – Manual Clamp and Lift.

Introduction

This configuration is available in 12" versions. Please check the model number in the model decoder in Section 10.

The Manual clamps are assembled and adjusted to fit the chair. The Lift is controlled by a lever on the Handlebar and has 3 positions – Parking, Short and Long Wheelbase positions.

If you want to remove/install the lifting mechanism, please sit on the chair first, turn the whole device over, then press Manual Lift Control Lever (8) with one hand, and remove/install the lifting mechanism with the other hand.

Procedure

Setting up the device on its legs with Clamps in position.

- Remove all parts from the packing box and check against Figure 11, below.

Handy Tip: If possible, keep the carton and packing in reserve against future needs for transporting.



Figure 11. Parts shown in their packing box

- Stand and support the device on its wheel. Install the Support Legs - allow them to support the device in a standing position. Ensure the locating bolts at the Supporting Legs are tighten fully.



Figure 12. Install and adjust the Support Legs to the Park Position



Attention! "Park" is the position required for docking and un-docking during the clamping steps

Parking Position

Touring Position

City Position

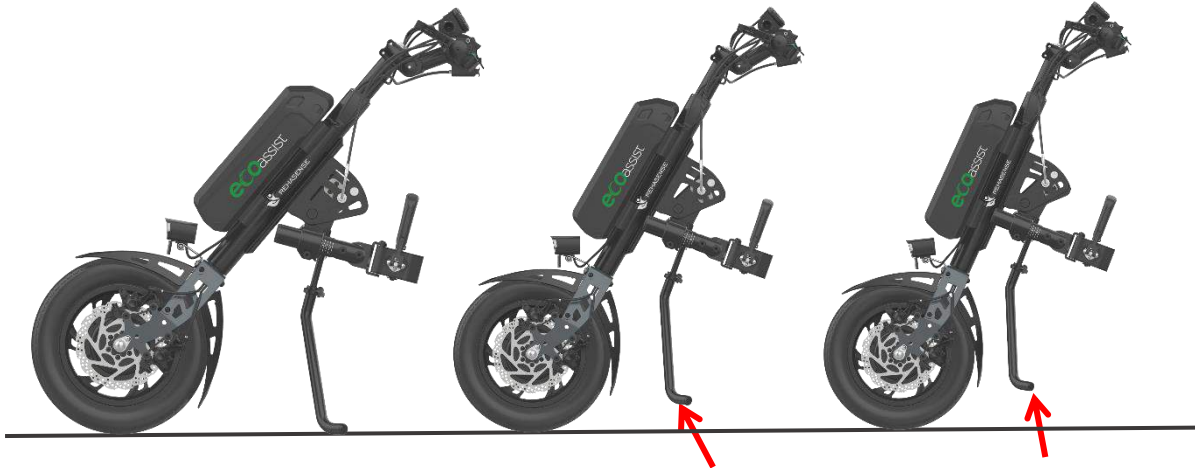

Figure 13. Different positions for the Lift Mechanism

(See Section 13 Operating for more information on driving positions)

- Set the Handlebars. Rotate the handlebars into the correct driving position. Tighten the hex bolts in the holding bracket to prevent the handlebars from unwanted movement.



Attention. The recommended Torque setting for these bolts is 8 Nm (Newton Meters).

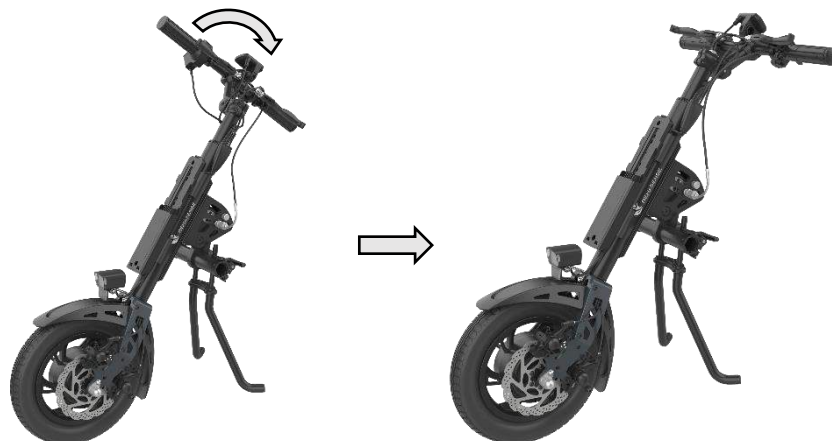

Figure 14. Fixing the Handlebars in the Operating Position

- Slide in the adjusting arms and insert the Manual Clamp Assembly into the two receiving holes. Pre-tighten the Manual Clamp Assembly. Once the width is established then lock them.

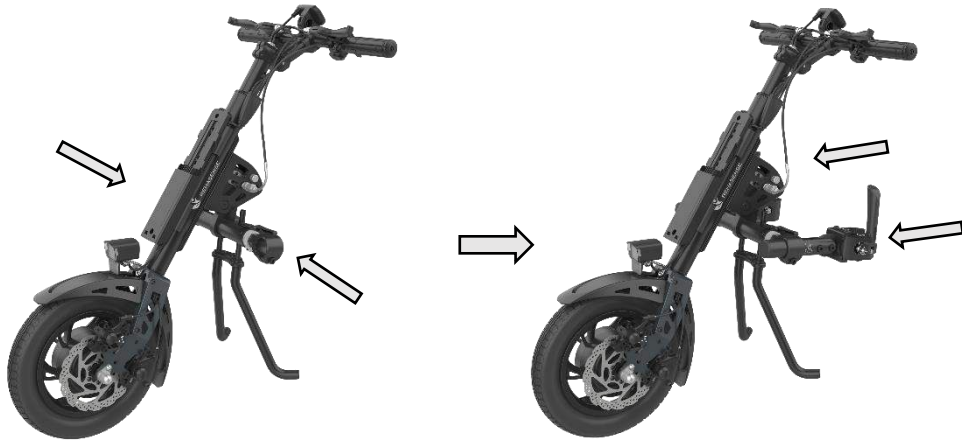

Figure 15. Assembling the Manual Clamp Assembly

Fitting to the chair.

Introduction

Connecting the chair to the device is important – only clamp the device to the front tubes of the chair and not to any removeable or swing away parts. It is important to clamp the device evenly to the chair. Please take time to ensure the best fit.

Fitting occurs in 2 stages, with 6 possible adjustments for each side. The first stage is to adjust all settings to an approximate fit. The second stage is after the Clamp Jaws are closed, then final micro-adjusting of angles, widths, height, and depth is made before tightening all bolts and nuts. See Figure 18.

Procedure

Setting the height of the device in relation to the chair.

- The height relationship can be adjusted by loosening the Bolts D at the top and bottom side of the Clamp Height Adjustment Centre Housing. See Figure 16 below. The centre housing will slide up and down toward the main frame.
- When docked, the Clamp Jaws should be in the middle section of the front chair tubes or where there is a section of straight tube slightly greater than the clamping area of the Clamp Jaws.

Attention! Avoid pinching on pipe sections that are not straight

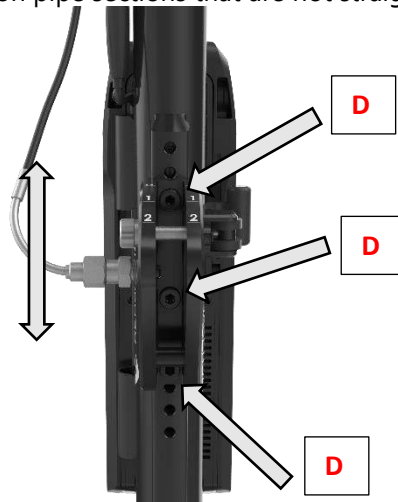

Figure 16. Different positions for Height Adjustment

⚠ Attention. The recommended Torque setting of Bolt D is 20 Nm (Newton Meters).

Setting the Clamp Jaws.

These need to be set for width, angle, and depth so that the clamping forces are equal for both sides.

- Adjust the width of the Clamp Jaws to the chair frame front tubes by loosening and tightening the Locking Clamp A to allow the Clamp Receiver Mechanism to slide in and out of its housing. Tightness of the Locking Clamp can be adjusted by the knob. See Fig 17 below.

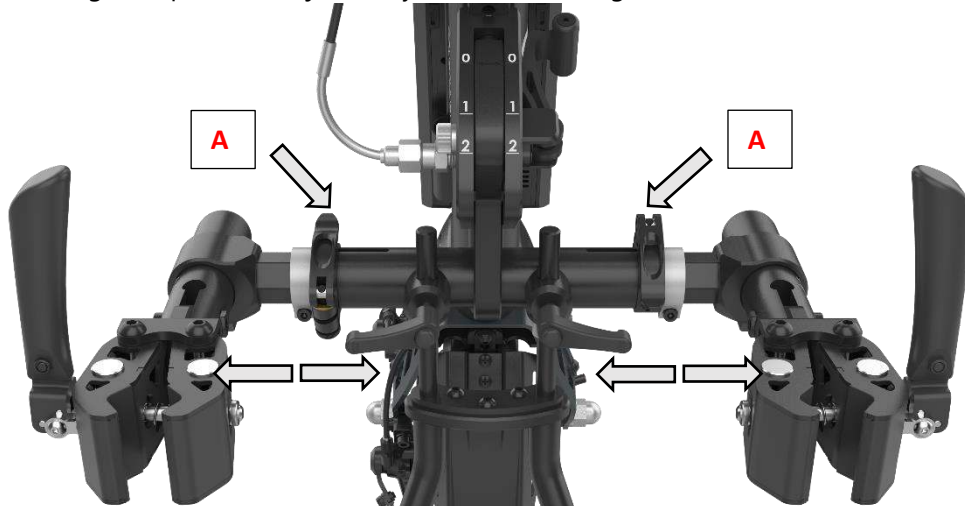

Figure 17. Adjusting width to fit with chair

- Once the centre of the Clamping Jaws is in line with the mid-line of the chair tubes, tighten the Locking Clamp.
- To fit with narrower/wider chair, the adjusting arms at both sides can be changed to shorter/longer version.

Adjust the jaw opening, to receive the front tube of the chair. Do this for both sides.

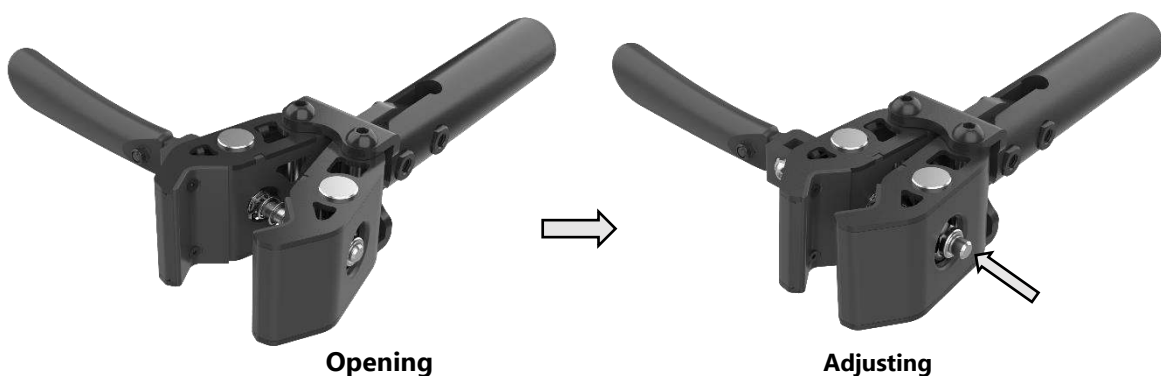

Figure 18. Opening and adjusting the width of the Clamp Jaws

- Adjust the lateral angle of the Clamp Jaws to the front tubes. Adjust the Clamp Jaw angle to the chair tube by rotating at Bolt C. the Clamp Jaws should grip the chair tube evenly when the Clamp Jaws are closed. Do this for both sides.

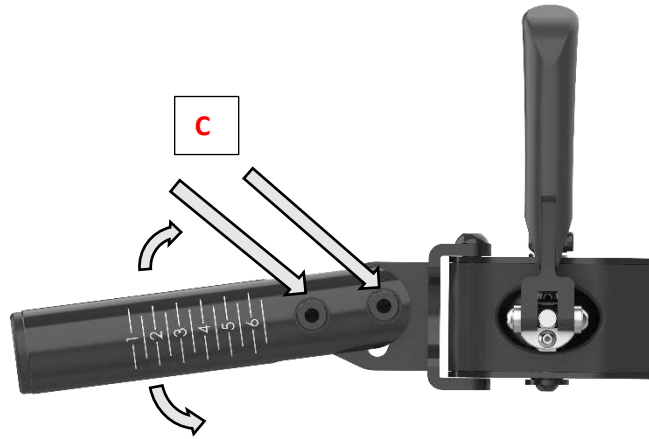

Figure 19. Changing the Lateral Angle of the Clamp Jaws

⚠ Attention. The recommended Torque setting of Bolt C is 25 Nm (Newton Meters).

- Setting the Frontal Angle of the Clamp Jaws to the front tubes. Rotate the Clamp Jaws so that they are parallel to the tubes.



Figure 20. Changing the Frontal angle of the Clamp Jaws

- Setting the depth of the Clamp Jaws to the device. Adjust the Clamp depth (determines the distance from the device to the chair) to ensure space between the Users knees and the device.

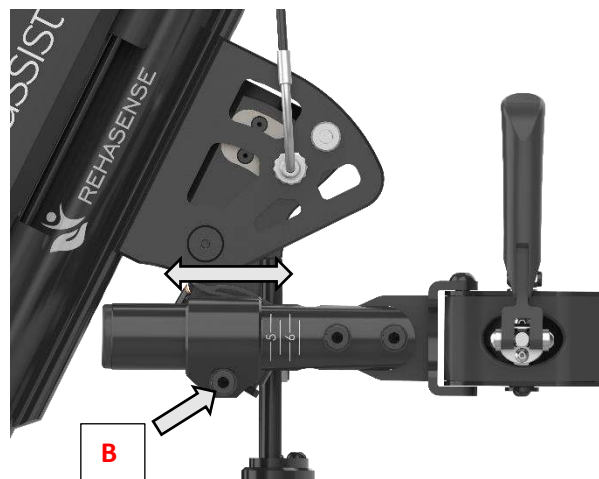



Figure 21. Showing the Depth adjustment of the Clamp mechanism in relation to the device



Attention! the Clamp mechanism and the Clamp Receiver must maintain full contact – do not extend the depth beyond what is possible with full contact of the Receiver and the Clamp mechanism.

Do this for both sides ensuring that the calibration marks for angle, rotation and depth are approximately the same.

- Close the Clamp Jaws and then adjust the Clamp Jaw Tensioning Nut (see “Figure 18. Opening and adjusting the width of the Clamp Jaws”) to 8 Nm Torque (example) or whatever the User is able to comfortably manage.
-  **Attention.** The recommended Torque setting of this depth adjustment Bolt B is 20 Nm (Newton Meters). See Fig 21 above.

The device is now ready to operate.

14. Operating

Description

This section describes the processes for starting up, operating, and shutting down the device with the chair.

Battery

- Ensure the battery is fully charged before a period of extended use.
- The battery should be fully charged after each use – this will extend the battery life.
- Remove the dust cover from the Battery Socket and insert the Charger Cable Plug to the socket.
- Observe the colored LEDs on the top of the battery – red indicates the lowest charge range (25% or less) and 3 green bars indicates the fullest range (75% to 100%)
- When charging, the level of charge will be indicated by a flashing LED Bar. When fully charged, the LED will be stable.
- For more detail on the Battery and Charger please see “Appendix 1: Battery and Charger”.

Clamping and Lifting

- Make sure the device is supported by the Supporting Legs.
- We ask you to perform the clamping and lifting on a level surface to ensure the best possible hold.
- Make sure that the ECO is locked by means of the brakes. See p. 33 (Brakes, Locking).
- Roll the chair into the device so that the leg tubes are inside the clamp jaws.
- Insert and Power up the Battery and turn on the Power button on the Handlebars.

To Clamp

- Close the jaws by rotating the Clamp Fix/Release Adjusting Lever.

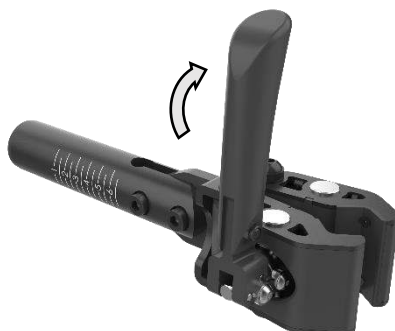

Figure 22. Clamp Fix/Release Adjusting Lever

⚠ Attention! After device is turned on, any actuation of throttle handle is a command to drive, so pay attention when the hands are on the throttle.

To Lift



Figure 23. Manual Lift Lever

- Press the Lift Lever while simultaneously pushing both handlebar grips forward and leaning back into the seat-back of the chair.

Driving Positions for Manual Lift Devices

- Apart from Parking, there are two other driving positions – City and Tour – and these are controlled during the Manual process.
- Touring is when the handlebars sit the lowest and the wheelbase is longest. This is best at higher speeds, providing greater stability and comfort.
- City is when the device is closest to vertical or at its tallest position. This means the wheelbase will be the shortest, enabling the greatest maneuverability. This is best if indoors and at low speed where tight corners need to be negotiated.

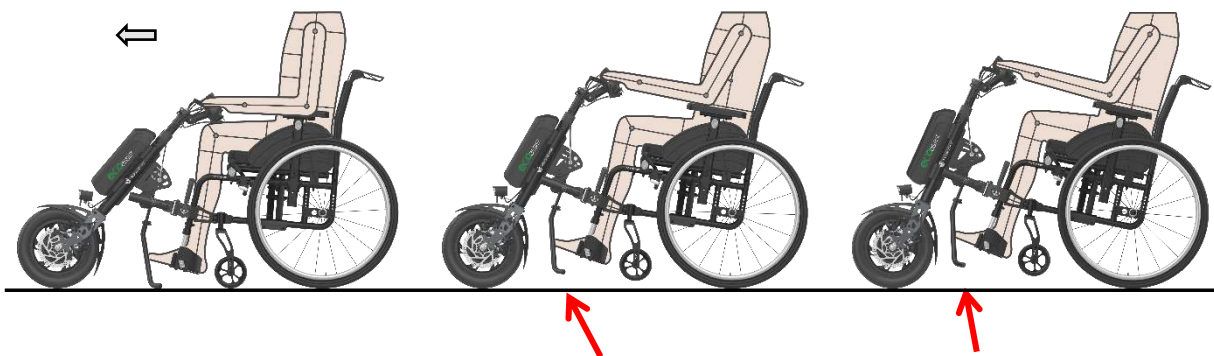

Figure 24. Parking (1), Touring (2) and City (3) and positions for Manual Clamp/Lift Devices

Leg supports.

⚠ Attention - The Supporting Legs can be height adjusted up and down so the users can adjust the space between their legs and handlebar! These should remain in the ready position to support the power add on when not

connected to the wheelchair. They may only be detached when the power add-on is put into the shipping box or needs to be laid down flat for transporting.

Driving

⚠ Attention - There is programmed 3 seconds delay during the setup for added safety when turning the device on. The throttle is inoperative during this 3 second delay. During this delay, the users should not operate the brake handles as these will affect the “power off” protection which may not release.

- Press the Power Device to power up the system.
- Attention – Never turn off the device while driving! This will turn off the electric brake function.
- Select the Speed Mode to set the maximum driving speed.



Figure 25. Power Device and Mode Selector Buttons

Mode	0	1	2	3
Top Speed	0 km/h	5 km/h	10 km/h	15 km/h

⚠ Attention! Speed Modes.

- Speed mode 1-3 are standard for all products.
- Speed limits are determined according to the local traffic regulations. These limits will be programmed at the time of manufacture and will be controlled in steps to reach the maximum permitted speed as determined by the traffic authorities. If a lower limit is required than the local regulations permit, then this can be programmed by the authorized Rehasense ECO representative in the delivery location.
- Rotate the throttle to the desired speed. Hold at this point to maintain the desired speed.
- Releasing the throttle will allow the drive wheel to “freewheel” or coast. Apply the brakes to slow down.

Display information viewing and settings

- Standby settings

Press and hold “+” and “-” at the same time, the system enters settings interface. Shortly press “+” or “-” to select “Standby Time”, then shortly press “on-off” to enter “Standby Time” settings. Shortly press “+” or “-” to set standby time, then shortly press “on- off” to save the settings. Shortly press “+” or “-” to select “Exit”, then shortly press “on-off” to quit the settings interface.



Standby settings

- Wheel diameter settings

Press and hold "+" and "-" at the same time, the system enters settings interface. Shortly press "+" or "-" to select "Wheel Select", then shortly press "on-off" to enter "Wheel Select" settings. Shortly press "+" or "-" to set wheel diameter, then shortly press "on-off" to save the settings. Shortly press "+" or "-" to select "Exit", then shortly press "on-off" to quit the settings interface.



Wheel diameter settings interface

- Speed limit settings

Press and hold "+" and "-" at the same time, the system enters settings interface. Shortly press "+" or "-" to select "Limit Speed", then shortly press "on-off" to enter "Limit Speed" settings. Shortly press "+" or "-" to set speed limit, then shortly press "on-off" to save the settings. Shortly press "+" or "-" to select "Exit", then shortly press "on-off" to quit the settings interface.



Speed limit settings interface

- Backlight setting

Press and hold "+" and "-" at the same time, the system enters settings interface. Shortly press "+" or "-" to select back light, then shortly press "on-off" to enter back light settings. Shortly press "+" or "-" to set back light level, then shortly press "on-off" to save the settings. Shortly press "+" or "-" to select "Exit", then shortly press "on-off" to quit the settings interface.



Backlight settings

- Distance unit settings

Press and hold "+" and "-" at the same time, the system enters settings interface. Shortly press "+" or "-" to select "Mile Unit", then shortly press "on-off" to enter distance unit settings. Shortly press "+" or "-" to set

distance unit, then shortly press "on-off" to save the settings. Shortly press "+" or "-" to select "Exit", then shortly press "on-off" to quit the settings interface.



Distance unit settings

- Total distance reset settings

Press and hold "+" and "-" at the same time, the system enters settings interface. Shortly press "+" or "-" to select "Trip Zero", then shortly press "on-off" to enter total distance reset settings. Shortly press "+" or "-" to select "YES" or "NO", then shortly press "on-off" to save the settings. Shortly press "+" or "-" to select "Exit", then shortly press "on-off" to quit the settings interface.



Total distance reset settings



Figure 26. Switches and Indicators (L to R) Direction; Cruise; Walk.

Direction

- Select the driving direction at the Direction Switch.
- Maximum speed in Reverse is 3 kmh.

Cruise Control

- Driving speed can be set without the need to hold the Throttle in position. This is done by using the Cruise function.
- Hold the throttle at a steady speed while pressing the Cruise button for 2 seconds.
- The Cruise function on the display is seen if the function is on.
- Manual throttle control can now be relaxed, and the Cruise function will maintain the set speed.

- To cancel the Cruise control speed, rotate the throttle or apply the brakes.



Without applying the brakes, the device will continue to coast. There is no automatic braking function.

Traction Control

- The Traction Control function lowers the wheel speed at start and increases the low r.p.m. torque so that wheelspin is minimized.
- This function is useful if the surface is slippery, or the slope is too great for a stationary start.
- It may be switched off once the device has traction and forward motion.

Driving Brakes

- For Standard control handlebars, driving brakes are applied by pulling the Brake Lever on left side of the Handlebar.

Parking Brake

- For Standard Control Handlebars, the Parking Brake is operated by a catch on left side of the brake handle levers. Pull the lever and engage the catch for parking brake with the fore finger. To release, pull on the Brake Lever and release the catch.

Safe Driving



- Always wear a crash helmet and a high visibility vest.
- Avoid sudden direction changes and only turn sharp angles at low speeds.
- Be aware of kerbs that have a significant camber – keep to a low speed and make turns slowly.
- When driving up the slope lean forwards to transfer the center of gravity to the front making the device more stable and providing better traction.
- When riding down the slope, lean backwards to transfer the center of gravity to the rear, making the device more stable.
- If the chair is parked on a slope, the parking brake must be applied as well as the chair brakes.
- When re-starting from being parked on a slope, simultaneously release the brakes, and gently apply the throttle to hold the device on the slope.
- Wherever possible, avoid parking on inclines and gradients.
- Do not use the chair brakes to slow down, only for parking.
- Please be careful to control the speed of the device by applying the brakes – the device does not have any automatic braking function!
- Please be especially careful when driving up or down slopes – use the brakes whenever not using the throttle!

Headlight

- The Headlight is a multi-function, high power LED light. It has an ambient light sensor which changes the light intensity according to the conditions.
- It also has a high and a low Beam, which is indicated by a yellow light for Low Beam and a blue Light for High Beam.

- Ensure the headlight is on whenever driving – car drivers may not see a wheelchair driver, and if they do, not expect the wheelchair to be going at more than walking speed.

Inclines, climbing ability and obstacles

- Eco assist = 3 degrees = 5.25%
-  **Attention!** If sufficient drive wheel traction cannot be made when starting on a slope, moving the upper body forward will move the center of mass closer to the front wheel which may aid in drive wheel traction.
-  **Attention!!** If stopping on an incline, the brake function on the device drive wheel may not be enough to hold the chairs, device, and driver at a stop position. Avoid stopping on such an incline. If this is unavoidable, apply the wheelchair brakes to control the movement of the device and chair.
-  **Attention!** If the User attempts gradients greater than 3 degrees, there is a possibility of losing traction. If this happens, engage the brakes, and reverse the steering to slowly turn around and go down the slope.
- When going over obstacles such as kerbstones, wherever possible engage them front on, or perpendicular to the obstacle, to prevent being tipped out of the chair.
- Always use a low speed when going over obstacles.

Powering down and disengaging

- To come to a full stop, go to “0” speed mode and engage the Parking Brakes (see “Section 4: General Usage”. Make sure the Supporting Legs are ready for the Park position.
- If Manual, press on the Lift Lock Lever while simultaneously pushing back on the Handlebars and the Seat Back. This will release the Lift Lock.
- Gently lower the device to the Park position. It is now safe to release the Clamp Locks and remove the chair from the device.

15. Accessories



Figure 27. Accessories (L to R) Tyre Inflator; Basket & Bag

Smart Tyre Inflator

A portable USB tyre inflator is used for checking tyre pressure and inflating tyres.

See "Appendix 3: Smart Tyre Inflator" for detailed operations.

Basket & Bag

A basket & bag is attached to the device for carrying of personal items. It is positioned over the front wheel and provides extra traction when carrying additional weight.

Note: Please ask your approved Rehasense ECO dealer about the full range of accessories available for ECO.

16. Appendices

16.1 Appendix 1: Battery and Charger

 **Attention!** Read carefully before charging and operating the first time.

Before starting up the power add-on and before charging the battery pack, read and observe the general information and instructions and the safety instructions and precautions in UM.

Failure to comply with the safety precautions and instructions may damage the product or result in electric shock, fire, and/or serious injuries.

The lithium-ion battery pack contains chemical substances that may damage caused by cause hazardous reactions if the safety instructions specified here are disregarded. We cannot take responsibility for non-compliance with the general information and abuse.

Due to the applicable transport regulations, the battery pack is only charged to a maximum of 30% on delivery.

You should fully charge it before putting it into first use.

Specifications:

- Cells: Panasonic Rated Voltage:48V
- Rated Capacity:5.8Ah
- Operating Voltage: 32.5-54.6V
- Standard Charging Current:2A
- Standard Discharging Current:7A
- Max Charging Current: 3A
- Max Discharge Current:15A
- Charging temperature range: 10-45
- Operating Temperature Range: -20-60
- Storage temperature range: -20-60 Storage
- Humidity: 45-85% RH
- Size of shell: 168mm*72mm*40mm
- Weight: 2 kg

Operating – Start up and LED indicators.

The “wake up” button and led display which shows the residual battery power is located on the top of battery pack.

4 LED lights: there are four lights which indicates differently under two modes: -

- In Using Mode

1 LED light up- 0% to 25% residual capacity available

2 LED light up-26% to 50% residual capacity available

3 LED light up-51% to 75% residual capacity available

4 LED light up-76% to 100% residual capacity available

Within each range, the brighter the LED, the more residual capacity remains.

- Under Charging mode

1 LED light flash- have been charged up to 0% - 25%

2 LED light flash-have been charged up to 26% - 50%

3 LED light flash-have been charged up to 51% - 75%

4 LED light flash-have been charged up to 76% - 100%

Note: The residual capacity of battery pack is indicated at two places: the screen display on the handlebar and LED lights on battery pack.

Inserting the battery pack to power add-on

- Use the bottom of the battery to touch the lower middle part of the plate on the Battery Holder,
- Stand up and hold the battery with your hand, push it parallel to the Battery Holder all the way down until you hear a click,
- Turn the key backward and simultaneously snap the Battery top to the Holder.

⚠ Attention! Observe whether the plate on the Battery Holder is completely covered by the battery.

If it is still exposed, reinstall the battery as above.



Figure 28. Inserting the Battery to the Battery Holder.

Removing the battery pack from power add-on

- Turn the key forward and simultaneously move the Battery top from Holder,
- Pull up the battery along the Battery Holder and move the battery out from the Holder.

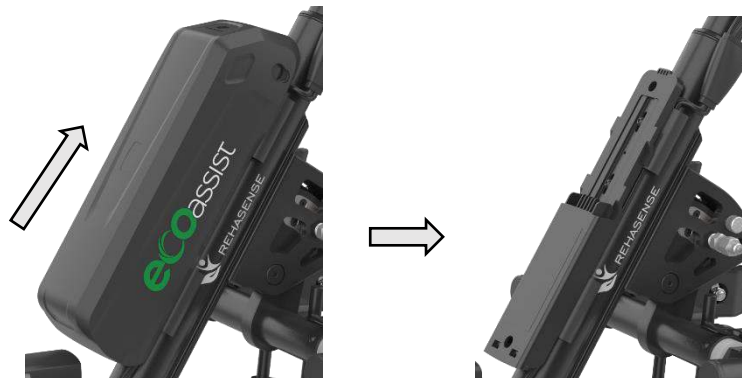

Figure 29. Removing and replacing the Battery.

Switching on/off the battery pack

- Switch on: press the button shortly to activate it.
- Switch off: press the button for a few second till the light is off.

Note: if under one of the below situations, the battery will enter sleeping mode after 30 minutes. Press shortly to inactivate it again.

- Output current less than 1A.
- Disconnected with controller signal.
- Charging current less than 100mA.

Charging the battery pack

- The battery can be charged both when it is in the device or separately:

It is recommended to take out the battery when charging.

- Connecting the charging plug to battery pack,
- Pull the rubber cover off the charger socket,
- Align the slot with the mark and Insert the charging plug into the charger socket,
- After charging, disconnect the charging plug from the charger socket,
- Place the rubber cover back on the charger socket.



Figure 30. Battery Charging Connection.



Warning! Handling and storing the battery.

- Do not use any batteries or cells not approved by the manufacturer!
- Please read the handling instructions for the battery carefully before using it. Improper use of the battery may cause heat, fire, rupture, damage or even worse consequences.
- Do not put the battery into fire or heat the battery; do not store the battery in places with higher temperature than that defines in this specification.
- Do not connect the battery, the charger or equipment with reversed positive (+) and negative (-) terminals.
- Do not connect the battery terminals (+ and -) with any wire or metal (like metal necklaces or hairpins). Otherwise, short-circuit may occur during carrying or storage.
- Do not drive a nail in the battery, hit it with a hammer, or stamp on it; Any other physical damage is also prohibited.
- Do not disassemble or alter the battery outside structure.
- Do not immerse the battery in water or otherwise get it wet.
- Performance and safety are only possible if the Battery is charged with original charger, in compliance with correct operating procedure, at a voltage and temperature within the specified ranges.
- The battery should be stored at room temperature with 40% to 60% of capacity. It must be charged monthly while in storage.
- The battery performance cannot be guaranteed if it is in storage for more than one year.



Attention! Light operation during battery charging.

If the Output Light is not working:

- Check whether there is alternating current.
- Check whether input side of charger is in poor contact.

If the Output Light (red) is always on, the battery maybe damaged. Check the battery function.

If above solutions cannot help solving the problem, please contact the dealer or manufacturer to rectify.

Note: Please do not make any technical modifications to the charger, as this a high voltage device and tampering could result in a high voltage shock and danger!

If there are any problems or questions, please contact your dealer or the manufacturer immediately!

16.2 Appendix 2: Headlight



Figure 31. Headlight

Description.

This lamp utilizes low energy LED's (Light Emitting Diodes) to provide lighting.

Specifications

Bike Light Certificate: ECE R113

Luminous Intensity (Lux/Lumens)

- High Beam:385LUX/1900LM
- Low Beam:100LUX/540LM

Power

- High Beam: 40 W
- Low Beam:9 W
- Working Voltage – 12V to 55V

Visible Distance :1200M

Waterproof Level: IPX4

Detailed Instructions.

- Hold for 2 seconds to power the light on or off.

16.3 Appendix 3: Smart Tyre Inflator

The Smart Tyre Inflator has a built-in rechargeable battery that drives a mini compressor for inflating tyres. Apart from automatically sensing the set pressure limits, the device can provide power for external devices and has a light function.



**150
PSI**
Ultra High Pressure

Automatic & Accurate

Quick Inflation













Small & Smart



LCD Display

LED Light



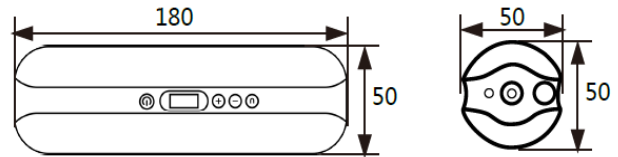

Power Bank

■ Packing List

			Inflator *1 Air Tube *1 USB Charging Cable *1
			Balloon Converter *1 Valve Converter *1 Ball Converter *1
			Bike Mount *1 Screwdriver *1 Screw *2
			Non-slip Mat *2 Velcro *1 Drawstring Bag *1



■ About Button

				
Press	Start / Stop inflating	Choose unit	Increase pressure	Reduce pressure
Long press	Turn on / off power	Turn on / off lighting	(Screen is on) Quick increase --- (Screen is off) Turn on / off power bank	Quick reduce

■ Details

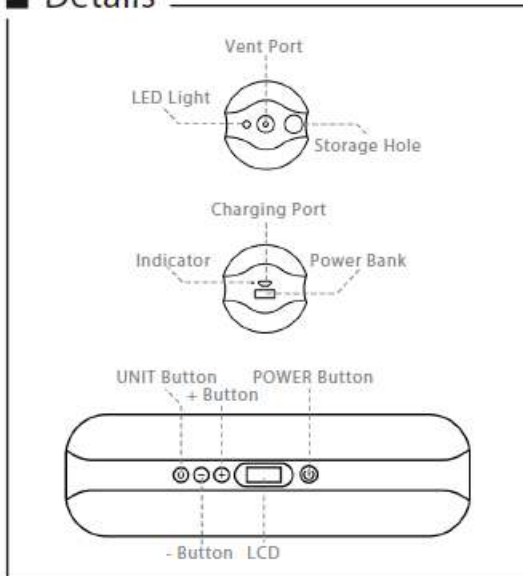

■ Specification

Size	50mm×50mm×180mm
Weight	336g
Battery	500mAh 12.8V
Work current	1-5A
Charging mode	Micro-USB
Charging time	2.5 hours
Max inflating pressure	150PSI & 10.3BAR 990KPA & 10.5kgf/cm ²
Operation temperature	-10°C ~ +60°C

Instructions.

1. Connect one end of the air tube to the inflator, connect another end to the tyre valve. (For the French valve, please install the valve converter at first)
2. Long press the POWER Button to turn on the power. The LCD will display the current pressure.
3. Pressing the UNIT button can switch the units (PSI\BAR\KPA/kg. /cm²). (The recommended range of pressure can be found on the tyre in general.)
4. The + Button and - Button are preset buttons for adjusting the target pressures. Long press them can adjust the target pressure quickly. (If skip Step 4, the target pressure is the value you preset last time.)
5. Pressing the POWER button can start inflating. Pressing it again, can pause/continue. It will stop automatically when it reaches the target pressure.
6. Please quickly remove the air tube from the tyre to prevent air leaks.
7. The inflator will not work when the target pressure you set is lower than the current tyre pressure.

About Lighting

1. Long press the unit button to turn on/off the LED light. The LED light can be used for lighting.

About Power Bank

1. Long press the + button, to turn on/off the power bank.
2. Power bank will be automatically turned off after 60 minutes.
3. If the power is turned on, the power bank will be turned off automatically.
4. Support Android and iOS equipment.

About Charging

1. For the first time to use or a long time no use, please charge Inflator first.
2. The charging indicator will turn red during the charging and turn green when the battery is fully charged.

Safety

1. The inflator become hot after working more than 1 min. Please do not touch the hot area of the air tube.



2. Please check the inflator before inflating. If you find any operating deviation, do not use it.
3. If you hear any abnormal sound or sense excessive temperature during the inflation, please stop immediately.
4. Please ensure the smooth flow of air during the inflating.
5. The compressor in the inflator may produce electric sparks while at work. Please keep it away from flammable and explosive objects.
6. Do not leave unattended during the inflating process, to avoid accidents.
7. After long-time using, both the inflator and the air tube will become hot. Please take a break before using it again
8. Please try to avoid contact with dust or moisture and avoid dropping.
9. Harsh chemicals, cleaning agents, detergents and other chemicals are forbidden to be used during the cleaning.
10. Do not store the inflator in a cold, hot, humid place.
11. If you do not use it for a long time, please charge it every six months.
12. The air tube can be stored in the storage hole.

13. Children are forbidden to use the inflator. Please keep it away from children.
14. Do not inflate the air into the mouth, ears, eyes, etc. of persons or animals.
15. Inflating is not recommended during the charging process.
16. The electricity displayed on the LCD is not accurate. It is only for reference.

17. Contact details of the distributor, manufacturer.

In case of any technical questions contact your local distributor or directly with The Manufacturer.

Distributor:

Rehasense® Sp. z o.o.

Sulejowska 45 G

97-300 Piotrków Trybunalski

Poland

www.rehasense.com

info@rehasense.com