



Fecha de pedido:

Nº de pedido de Sunrise:

PVP Rec: 5.694,40 €

TGAXZ010

**Cod. SRM030D (Mejora) **

Peso máximo usuario: 125 kg

Los precios aquí mostrados son Precios de Venta al Público Recomendados sin IVA

Datos contacto cliente

Facturado a:

Nombre:

Calle:

Localidad:

Código postal:

Email:

Teléfono: Fax:

Enviado a:

Nombre:

Calle:

Localidad:

Código postal:

Email:

Teléfono: Fax:

Datos relevantes del usuario para la configuración de la silla

Nombre:

Patología/lesión:

Otros datos usuario:

Nota plazo de entrega RGK - Importante

Cada silla RGK es trabajada de forma individualizada y con los más altos estándares de Calidad durante todo el proceso de fabricación desde la recepción del pedido. Este proceso artesanal implica que los plazos de entrega son orientativos garantizando siempre la personalización de la silla al mínimo detalle.

Una vez se recepciona el pedido en fábrica con todos los detalles de la silla confirmados, se procede a la realización del plano CAD personalizado. El plazo de entrega para este plano es de aproximadamente 3 semanas, pudiendo variar dependiendo del volumen de planos a realizar en ese momento.

Una vez revisado el plano por el cliente, debe devolverse firmado con su conformidad para que pase a producción y se comience a fabricar la silla según las medidas y forma indicadas en plano. Hay que tener en cuenta que si se efectúan modificaciones en el plano, se realizará uno nuevo, ya que solo pasa a producción el plano con las medidas definitivas aprobadas. Este proceso puede llevar varios días o semanas, por ello se recomienda ser ágil en la revisión y devolución del plano firmado, evitando la demora en el inicio de fabricación.

Una vez que en RGK tenemos el plano definitivo, el plazo de fabricación de la silla son 5 semanas (transporte incluido), siempre y cuando la silla pase con éxito los tests de Calidad establecidos. Al ser un producto totalmente personalizado y fabricado individualmente bajo los más exigentes estándares de calidad, este plazo puede variar para garantizar el resultado óptimo de la silla.

Guía:

Modelo

Configuración standard

Opción

Dato obligatorio

Dato necesario

PRODUCTO

TGAXZ010 TIGA
5.694,40 € **TIGA**

- XA070 Armazón abierto **Open design**
- XA080 Armazón cerrado **Closed design**
- TGAXA085 Versión Crash Tested
281,37 € **Crash tested upgrade**
- XA170 Armazón reforzado (Heavy duty)
597,72 € **Heavy duty frame**
(Necesario seleccionar ruedas Spinergy SLX 24 radios)

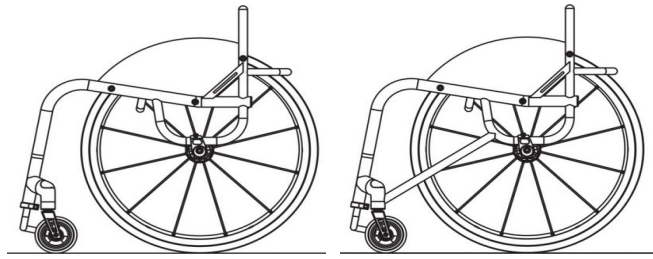

XA070 - Armazón abierto

XA080 - Armazón cerrado

Peso máximo usuario 125 kg

Peso máximo usuario con armazón reforzado 158 kg

NOTA: LAS SILLAS RGK SE FABRICAN A LA MEDIDA DEL USUARIO Y TIENEN UNA TOLERANCIA DE FABRICACIÓN DE +/- 5MM

DIBUJO CAD

- XW010 Pedido / DIBUJO CAD para aprobación final
(Incluido sólo en pedidos firmes. Para presupuestos consultar con Atención al Cliente.)
(Incluye 2 modificaciones por parte del cliente. La tercera modificación tendrá un coste de 150 €)
ORDER CAD drawing for approval (2 amendments ONLY)

MEDIDAS DEL CHASIS

XY010 Anchura de asiento: (de parte interna a parte interna del protector lateral)
Seat width (Inside to inside of sideguards)



(Max - 500mm)

XY020 Profundidad de asiento:
Seat length



(Max - 500mm)

XY030 Profundidad adicional sin tapicería:
(superficie adicional para soporte de piernas y agarre durante las transferencias)
Extra Seat Length (Provides additional leg support & hand grip)



XY050 Altura delantera de asiento:
Front frame height



(Max - 550mm)
(Min - 380mm)

XY060 Altura trasera de asiento:
Rear frame height



(Max - 550mm)
(Min - 360mm)

XY070 Profundidad total de chasis:
Frame length



(Min = XY020 + XY030 + 140mm)

XY072 Posición de las ruedas delanteras:
Castor position



Medidas optimizadas
Optimise measurements

Posición de la rueda delantera TX
TX Forward Castor Position

XA020 Asiento ergonómico
128,34 € **Ergonomic seat**
Especificar longitud



(Standard = 120mm)

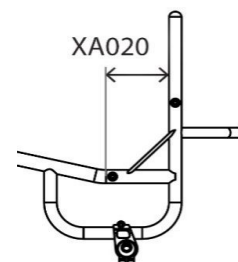
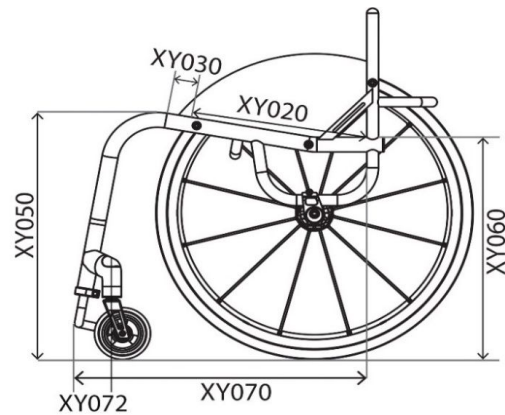
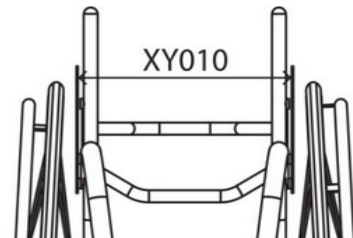

CHASIS DELANTERO Y REPOSAPIÉS

Opciones de chasis delantero

- XY080 Anchura de asiento taper (estrechamiento de asiento)
Seat taper design

Especificar anchura



(Cuando es combinado con XY091, la referencia para el estrechamiento de asiento se toma en el centro de ambas curvaturas, ver indicación en foto del dibujo derecho)

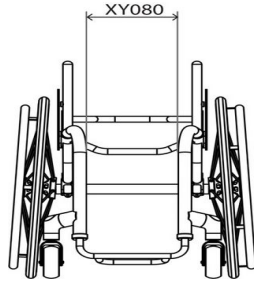

- XY091 Anchura de armazón frontal (estrechamiento de reposapiés)
Parallel taper design

Especificar anchura



(En combinación con XY080, las medidas deben ser menores en 20 mm)

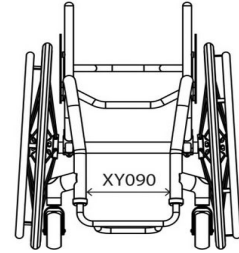

Reposapiés: diseño y medidas

- XY100 Diseño redondo
Round design

Rueda delant.	Altura máx.	Con XB200
3"	115mm	165mm
4"	125mm	175mm
5"	135mm	185mm

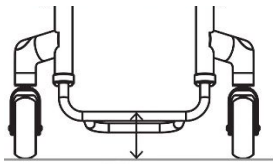

- XY105 Diseño cuadrado
Square design

Rueda delant.	Altura máx.	Con XB200
3"	135mm	185mm
4"	145mm	195mm
5"	155mm	205mm

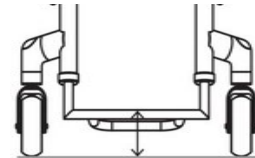

- XB200 Elevador de plataforma soldado
225,52 € (Sólo con XB010, XB080 & XB150)
High level footrest

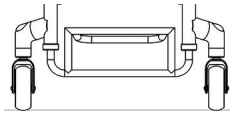

- XB200 Elevador de plataforma soldado
225,52 € (Sólo con XB010, XB080 & XB150)
High level footrest

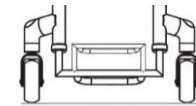

Reposapiés: diseño y medidas

- XY115 Altura delantera de reposapiés
Front footrest height



- XY120 Altura trasera de reposapiés
Rear footrest height



(Standard = Altura delantera reposapiés - 20 mm)

- XY125 Profundidad de reposapiés
Footrest length



(Std = 100mm) (A partir de 160 mm se requiere la actualización Heavy Duty XB150)
(160mm and over requires heavy duty upgrade XB150)

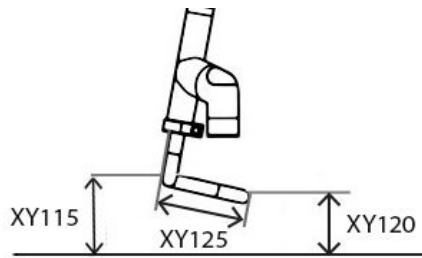

Tipo de reposapiés

- XB010 Reposapiés tubular de aluminio (Ajustable en altura)
Tubular aluminium footrest (Height adjustable)

- XB030 Reposapiés dividido con plataforma de composite (Ajustable en altura y ángulo, disponible sólo con armazón cerrado)
430,27 €
Flip up plastic footrest (Angle/height adjustable, with closed frame only)

- XB070 Reposapiés con plataforma de aluminio (Ajustable en altura y ángulo)
179,52 €
Angle adjustable aluminium footrest (Angle/height adjustable)

- XB150 Reposapiés tubular reforzado, ajustable en altura (Ajustable en altura)
225,52 €
Heavy duty tubular footrest (Height adjustable, for Freewheel use)

- TGAXB080 Reposapiés soldado en el chasis (No ajustable en altura)
143,19 €
Tubular footrest welded into frame (No height adjustment)

Plataformas **Cód. SRC010A (Mejora)**

- XB050 Plataforma de carbono (No posible con XB070 & XB030)
212,93 €
Carbon fibre cover (Not with XB070 & XB030)

- XB170 Plataforma de aluminio (No posible con XB070 & XB030)
109,80 €
Aluminium cover (Not with XB070 & XB030)

- XB040 Plataforma ABS (No posible con XB070 & XB030)
109,80 €
Plastic Cover (Not with XB070 & XB030)

- XB165 Tape antideslizante 3D para plataformas (No disponible con XB030)
59,34 €
Rubber grip tape

RUEDAS DELANTERAS, HORQUILLAS Y FRENOS

Ruedas delanteras 100mm (4")

- XC060 Ruedas delanteras 4x1.3" macizo blando color negro
Soft roll 4"x1.3" (Black only)
- XC110 Ruedas delanteras 4x1" con llanta de aluminio y cubierta maciza negra
204 € Aluminium centre 4"x1" (Silver hub and black urethane tyre only)
- XC130 Ruedas delanteras 4x1.4" con llanta de aluminio y cubierta maciza
204 € (Selecciona abajo el color)
Aluminium centre 4"x1.4" (choose colour below)



- | | | |
|--|---|---|
| <input type="checkbox"/> Llanta plata y cubierta negra (Std)
Silver hub & black tyre (Std) | <input type="checkbox"/> Llanta dorada y cubierta negra
Gold hub & black tyre | <input type="checkbox"/> Llanta morada y cubierta negra
Purple hub & black tyre |
| <input type="checkbox"/> Llanta negra y cubierta negra
Black hub & black tyre | <input type="checkbox"/> Llanta verde y cubierta negra
Green hub & black tyre | |
| <input type="checkbox"/> Llanta roja y cubierta negra
Red hub & black tyre | <input type="checkbox"/> Llanta azul y cubierta negra
Blue hub & black tyre | |

125mm (5")

- | | |
|--|--|
| <input type="checkbox"/> XC070 Ruedas delanteras 5x1.3" macizo blando negro
Soft roll 5"x1.3" (Black only) | <input type="checkbox"/> XC120 Ruedas delanteras 5x1" Frog Legs
204 € (con llanta aluminio y cubierta maciza negra)
Aluminium centre 5"x1" (Silver hub and black urethane tyre only) |
| <input type="checkbox"/> XC100 Ruedas delanteras 5"x1" neumáticas con llanta de aluminio y cubierta gris
228,50 € Pneumatic Aluminium centre 5"x1" (Grey only) | <input type="checkbox"/> XC140 Ruedas delanteras 5x1.4" Frog Legs
204 € (con llanta aluminio y cubierta maciza negra)
Aluminium centre 5"x1.4" (Silver hub and black urethane tyre only) |

150mm (6")

NOTA: Siempre con horquillas extruidas. No es necesario seleccionar abajo el tipo de horquilla.

- | | |
|---|--|
| <input type="checkbox"/> XC080 Ruedas delanteras 6x1.3" macizo blando negro
(Llanta negra y cubierta gris)
Soft roll 6"x1.3" (Black hub / grey tyre only) | <input type="checkbox"/> XC145 Ruedas delanteras 6x1.4"
204 € (con llanta aluminio y cubierta maciza negra)
Aluminium centre 6"x1.4" (Silver hub and black urethane tyre only) |
|---|--|

Horquillas

- | | |
|---|--|
| <input type="checkbox"/> XC190 Horquilla Performance
Performance castor fork
<i>El color de la horquilla será igual al elegido en detalles (pág. 9)</i> | <input type="checkbox"/> XC210 Horquilla Frog Legs con suspensión
564,71 € Froglegs suspension castor fork |
| <input type="checkbox"/> XC192 Horquilla anti-vibración
High trail castor fork
<i>La mayor distancia entre la superficie de contacto y el eje de dirección reduce el aleteo a altas velocidades.</i>
<i>El color de la horquilla será igual al elegido en detalles (pág. 9)</i> | <input type="checkbox"/> Negra
Black <input type="checkbox"/> Gris plata
Silver |

Ancho entre ruedas delanteras

- XY330 Ancho entre ruedas delanteras:
Castor pin width



- Medidas optimizadas:
(para permitir el giro de ruedas y base para mínima resistencia al rodaje)
Optimise measurements

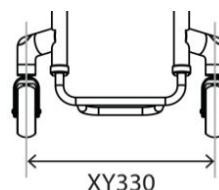

Frenos

- | | |
|--|--|
| <input type="checkbox"/> XD020 Frenos de tijera (bajo el asiento)
Underseat Scissor | <input type="checkbox"/> XD050 Frenos de empuje
Push to lock |
| <input type="checkbox"/> XD030 Frenos compactos
304,15 € Compact scissor | <input type="checkbox"/> XD046 Frenos de empuje Out-Front
214,73 € Out Front push to lock |
| <input type="checkbox"/> XD035 Frenos compactos con montaje ligero
304,15 € (sólo con centro de gravedad fijo)
Compact scissor with lightweight fixing (Only with fixed centre of gravity) | <input type="checkbox"/> XD085 Frenos Eagle (Indicar color abajo)
307,63 € Eagle Brakes (Indicate colour) |
| | <input type="checkbox"/> XD086 Frenos Eagle con montaje ligero
344,76 € (Indicar color abajo)
Eagle Brakes with L/W fixing (Indicate colour) (Only with fixed centre of gravity) |

- | | | | |
|--|--|---|--|
| <input type="checkbox"/> NEGRO
BLACK | <input type="checkbox"/> MORADO
PURPLE | <input type="checkbox"/> ROJO
RED | <input type="checkbox"/> AZUL
BLUE |
|--|--|---|--|



- XD010 Sin frenos
Omit wheel locks

PROTECTORES LATERALES Y REPOSABRAZOS

SIN FENDER ALUMINIO

- XE030 Protectores laterales de aluminio fijos
283,40 €
Screw on aluminium
- XE080 Protectores laterales de aluminio extraíbles
651,33 €
Lift out aluminium
- TGAXE130 Protectores laterales de aluminio plegables
565,26 €
Fold flat aluminium
- XE180 Protectores laterales de aluminio abatibles
338,29 €
Flip back aluminium

ALUMINIO SOLDADO

- TGAXE220 Protectores laterales de aluminio soldados
430,27 €
(Borde reforzado 6 mm)
Welded with 6mm bead
- TGAXE230 Protector aluminio soldado sport
602,38 €
(Extra fuerte) (Borde reforzado 16 mm)
Welded aluminium sport (Extra strong)

CARBONO

- XE050 Protectores laterales de carbono fijos
632,81 €
Screw on carbon fibre
- XE100 Protectores laterales de carbono extraíbles
882,06 €
Lift out carbon fibre
- TGAXE150 Protectores laterales de carbono plegables
914,70 €
Fold flat carbon fibre
- XE200 Protectores laterales de carbono abatibles
685,47 €
Flip back carbon fibre

ABS

- XE070 Protectores laterales ABS fijos
283,38 €
Screw on ABS plastic
- XE120 Protectores laterales ABS extraíbles
422,85 €
Lift out ABS plastic
- TGAXE170 Protectores laterales ABS plegables
565,28 €
Fold flat ABS plastic

Medidas de los protectores Medidas optimizadas

- Altura de 25mm sobre la rueda
25mm above tyre (Follow tyre)
- Altura individualizada sobre la rueda:
- Altura a nivel de la rueda
Level with tyre (Follow tyre)

Medidas personalizadas

- Longitud del protector
Sideguard length
- Altura del protector
Sideguard height

CON FENDER ALUMINIO

- XE040 Protectores laterales de aluminio con fender fijos
338,29 €
Screw on aluminium with fender
- XE090 Protectores laterales de aluminio con fender extraíbles
706,24 €
Lift out aluminium with fender
- TGAXE140 Protectores laterales de aluminio con fender plegables
620,19 €
Fold flat aluminium with fender
- XE190 Protectores laterales de aluminio con fender abatibles
393,19 €
Flip back aluminium with fender

CARBONO

- XE060 Protectores laterales de carbono con fender fijos
830,85 €
Screw on carbon fibre with fender
- XE110 Protectores laterales de carbono con fender extraíbles
1.027,47 €
Lift out carbon fibre with fender
- TGAXE160 Protectores laterales de carbono con fender plegables
1.080,35 €
Fold flat carbon fibre with fender
- XE210 Protectores laterales de carbono con fender abatibles
830,85 €
Flip back carbon fibre with fender

Medidas de los protectores Altura del fender

- 10 mm sobre la rueda (Standard)
10mm above tyre (Standard)
- Altura individualizada sobre la rueda
Individual above tyre
(Min = 10mm)
 mm

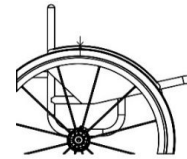

Anchura del fender

- Anchura del fender hasta centro de la cubierta
(Standard si no se selecciona ninguna opción)
Centre of tyre
(Standard if no option selected)
- Anchura del fender hasta la parte exterior de la cubierta
Outside of tyre

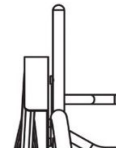
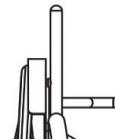

Reposabrazos

- XF010 Reposabrazos extraíbles con protector de composite y almohadillado
727,01 €
(altura fija)
Lift out armrest with plastic sideguard (Indicate fixed height)
- XF020 Reposabrazos extraíbles con protector de aluminio y almohadillado
727,01 €
(altura fija) **(Indicate fixed height)**
Lift out armrest with Aluminium sideguard

Parte superior tubo de asiento a parte superior del almohadillado
Height (Top of seatrail to top of armrest)

- Indicar altura

RESPALDO

Altura del respaldo

- XY230 Respaldo con altura fija
Fixed height backrest



Especificar altura

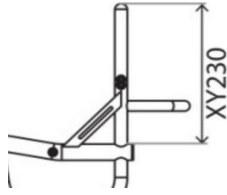

- XY245 Respaldo ajustable en altura
212,90 € (+/-25mm)
Adjustable height backrest



Especificar altura

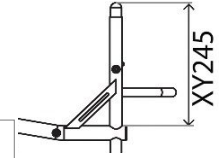

Diseño del respaldo (selecciona una opción)

- XG010 Respaldo fijo (No-plegable)
Fixed backrest (Non-folding)

- TGAXG020 Respaldo plegable (con doble sistema de bloqueo y ajustable en ángulo $\pm 5^\circ$)
532,66 €
Folding backrest
(with 2 position snap lock and angle adjust ± 5 Deg)

Opciones ergonómicas

- XY360 Ángulo del respaldo:
Backrest angle



-5 -3 0 +3 +5

Individual

(Max -10/+20 Deg)

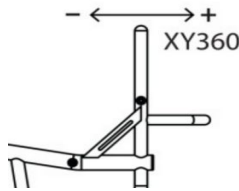

- XG100 Respaldo ergonómico
128,34 €
Ergonomic backrest



Altura vertical:



Inclinación posterior:

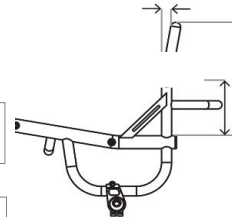

- XG110 Respaldo Taper In (Estrechamiento)
128,34 €
(por encima de los protectores laterales)
Inward taper
(inside of backrest posts)
Anchura:



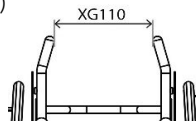

- XG120 Respaldo Taper Out (Ensanchamiento)
128,34 €
(por encima de los protectores laterales)
Outward flare
(inside of backrest posts)
Anchura:



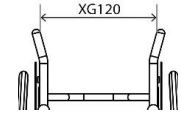

Empuñaduras

- XG070 Empuñaduras extraíbles (No con XY245)
250 €
Screw in push handles (N/A with XY245)

- XG080 Empuñaduras plegables (No con XY245)
383,01 €
Flip down push handles (N/A with XY245)

- XG085 Empuñaduras plegables ajustables en altura
401,16 €
(No con XY245)
Flip down push handles height adjustable
(N/A with XY245)

- XG090 Empuñaduras ajustables en altura
441,39 €
Stroller push handles height adjustable
Altura desde el suelo hasta la parte superior de las empuñaduras



Altura optimizada (1000mm desde el suelo)

- XG097 Empuñaduras integradas
321,23 €
(Diseño Quickie)
Integrated push handle (Quickie design)

Opciones de respaldo

- XG040 Respaldo fijo reforzado
196,68 €
(recomendado para handbikes)
(no posible con respaldo ajustable en altura XY245)
Heavy duty backrest upgrade
(Recommended for hand cycling) (Not with XY245)

- XG130 Barra rigidizadora con profundidad extra
128,34 €
(Recomendada para respaldos JAY) (Std - 90mm)
Extra deep Square brace bar
(Recommended for JAY backs) (Std - 90mm)



Profundidad personalizada:

ILSA - Opciones de respaldo

- XG140 Soportes laterales ajustables integrados en el respaldo
499,67 €
Integrated lateral support

A - Lado izquierdo

A - Lado derecho

B - Lado izquierdo

B - Lado derecho

C - Lado izquierdo

- Lado derecho

D - Lado izquierdo

D - Lado derecho

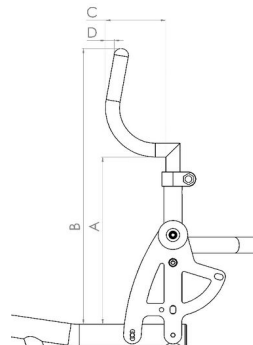

CENTRO DE GRAVEDAD

AJUSTABLE*

- XH110 Diseño cuadrado (25-150 mm)
Square back adjustable centre of gravity (25-150mm)

Indicar medida:

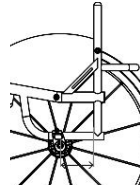

- XH120 Diseño redondo (60-150mm)
Round back adjustable centre of gravity (60-150mm)

Indicar medida:

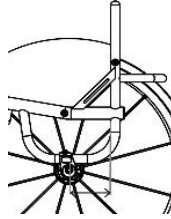

Camber

- XY390 Seleccione Camber
Camber angle
- 0 1 2 3 5

Opciones

- XH040 Tubo adicional para handbike soldado
Handbike camber bar fixed
447,34 €

i Ángulo Camber (Tubo adicional para handbike)
Camber angle (Handbike camber bar)
0 5

i Altura de rueda delantera a suelo, para uso con handbike:
(Standard 30mm, si no se indica otra medida)
Castor height from floor for handbike fitting
(Standard 30mm if not indicated)
30 50

- XH030 Tubo del eje con suspensión Frog Legs
Frogllegs suspension camber bar
1.074,20 €

FIJO

- TGAXH100 Diseño monotubo (25-125mm)
532,66 €
(Sólo con armazón abierto)
(No posible con la versión Crash-Tested)
Single post fixed centre of gravity
(Open frame only)
(Not with Crash test option)

Indicar medida:

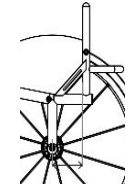

- TGAXH090 Diseño en V (25-125mm)
532,66 €
V-style fixed centre of gravity

Indicar medida:

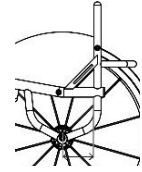

Camber

- XY390 Seleccione Camber
Camber angle
- 0 1 2 3 5

Opciones

- XH040 Tubo adicional para handbike soldado
Handbike camber bar fixed
447,34 €

i Ángulo Camber (Tubo adicional para handbike)
Camber angle (Handbike camber bar)
0 5

i Altura de rueda delantera a suelo, para uso con handbike:
(Standard 30mm, si no se indica otra medida)
Castor height from floor for handbike fitting
(Standard 30mm if not indicated)
30 50

Opciones de antivuelcos **Cód. SRA030G (Mejora)**

- XJ010 Antivuelco abatible unilateral izquierdo
229,14 €
(sólo con diseño cuadrado de armazón. No posible con XH040)
Swingaway anti tip LEFT side (Only with square back frame. Not with XH040)

- XJ100 Antivuelco unilateral Sport
525,46 €
(montaje central)
Single sport anti tip (centre mounted)

- XJ020 Antivuelco abatible unilateral derecho
229,14 €
(sólo con diseño cuadrado de armazón. No posible con XH040)
Swingaway anti tip RIGHT side (Only with square back frame. Not with XH040)

*** NOTA:** Con protector lateral con fender el ajuste del COG está limitado a 10 mm hacia delante y 25 mm hacia atrás.
Si necesita mayor rango de ajuste, indíquelo en la sección "Notas" de la última página

RUEDAS TRASERAS

Tamaño	
<input type="checkbox"/> XY420 24" 24" Wheels	<input type="checkbox"/> XY430 25" 25" Wheels
<input type="checkbox"/> XY440 26" 26" Wheels	

Espacio rueda-chasis

XY460 Espacio de la rueda al chasis
Rear wheel gap

15 20 25

Individual



Tipos de ruedas

<input type="checkbox"/> XK010 Sun Fusion, 16 radios Fusion 16 spoke 1.119,44 €	<input type="checkbox"/> XK050 Spinerger LX 12 radios Spinerger LX 12 spoke	<input type="checkbox"/> XK150 Spinerger CLX de 18 radios Blade (llanta de carbono) No con carrete gris plata Spinerger CLX 18 carbon blade spoke N/A IN SILVER HUB 1.825,68 €	<input type="checkbox"/> XK080 Spinerger SLX 24 radios Spinerger SLX 24 spoke 1.119,44 €	<input type="checkbox"/> XK320 Spinerger XLX 12 radios cruzados (seleccionar color) Spinerger XLX 12 spoke (cross/radial spoked) 1.178,80 €	<input type="checkbox"/> XK060 Spinerger SPOX 18 radios (selecciona abajo el color) Spinerger SPOX 18 spoke 842,74 €	<input type="checkbox"/> XK070 Spinerger BLXL 18 radios (selecciona abajo el color- Carrete sólo en negro) N/A IN SILVER HUB 1.178,80 €
---	--	--	--	--	--	---

Opciones de colores para ruedas Spinerger:

<input type="checkbox"/> Radios negros Black spokes	<input type="checkbox"/> Radios blancos White spokes	<input type="checkbox"/> Radios amarillos Yellow spokes	<input type="checkbox"/> XK180 Colores personalizados para ruedas Spinerger Individual spoke design 261,83 €
<input type="checkbox"/> Radios rojos Red spokes	<input type="checkbox"/> Radios azules Blue spokes	<input type="checkbox"/> Radios rosas Pink spokes	Interiores: <input type="text"/>
<input type="checkbox"/> Radios morados Purple spokes	<input type="checkbox"/> Radios naranjas Orange spokes	<input type="checkbox"/> Radios verdes Green spokes	Exteriores: <input type="text"/>

Opción de color anodizado

<input type="checkbox"/> XK190 Carrete negro (std option) Black hub 137,23 €	<input type="checkbox"/> XK200 Carrete gris plata (No con BLXL/CLX) Silver hub 137,23 €	<input type="checkbox"/> XK201 Carrete y llanta rojo (LX, XLX & BLXL only) Red hub/rims 210,33 €	<input type="checkbox"/> XK205 Carrete y llanta en color personalizado Especificar color: Individual: Select colour: 275,33 €
<input type="checkbox"/> XK202 Carrete y llanta morado (LX, XLX & BLXL only) Purple hub/rims 210,33 €	<input type="checkbox"/> XK203 Carrete y llanta azul (Sólo con LX, XLX & BLXL) Blue hub/rims 210,33 €	<input type="checkbox"/> XK204 Carrete y llanta dorado (LX, XLX & BLXL only) Gold hub/rims 275,33 €	<input type="text"/>

Sin ruedas

XK040 Sin ruedas
Supply without Wheels

Posición del aro

<input type="checkbox"/> XY480 Montaje estrecho Narrow set handrim 163.19 €	<input type="checkbox"/> XY485 Montaje ancho Wide set handrim
<input type="checkbox"/> XL090 Cortar patillas del aro Remove excess mounting tabs 163.19 €	(Recomendado si la distancia entre chasis y rueda es 20 mm o menos) (recommended for small wheel gaps)

Aros

<input type="checkbox"/> XL010 Aros de aluminio anodizado con 6 uniones (Standard si no se selecciona ninguna otra opción) Aluminium hard anodised 6 tab 471,31 €	<input type="checkbox"/> XL040 Aros de titanio con 6 uniones Titanium 6 tab 386,50 €
<input type="checkbox"/> XL160 Aros Elipse con 6 uniones Elipse 6 tab 471,31 €	<input type="checkbox"/> XL035 Aros Natural Fit LT Natural Fit LT 471,31 €
<input type="checkbox"/> XL020 Aros Tetra Grip con 6 uniones Tetra grip 6 tab 456,25 €	<input type="checkbox"/> XL150 Aros Carbolife Gekko Carbolife Gekko 793,48 €
<input type="checkbox"/> XL100 Aros Para Grip con 6 uniones Para grip 6 tab 456,25 €	<input type="checkbox"/> XL170 Aros Carbolife Curve L Carbolife Curve L (Black) 825,30 €

Cubiertas

<input type="checkbox"/> XM010 Kenda <input type="checkbox"/> Gris (Std) <input type="checkbox"/> Azul <input type="checkbox"/> Rojo Kenda color negro Kenda black 29,67 €	<input type="checkbox"/> XM060 Schwalbe One (sólo para 24" y 25") Schwalbe One (24", 25" only) 152,07 €
<input type="checkbox"/> XM020 Schwalbe Marathon Plus Schwalbe Marathon Plus 122,90 €	<input type="checkbox"/> XM050 Kenda K885 mountain bike tyre (sólo 24" y 25") Kenda K885 mountain bike tyre (24", 25" only) 43,04 €
<input type="checkbox"/> XM040 Shox maciza, color negro Shox solid airless (Black only) 179,52 €	

Válvulas

<input type="checkbox"/> XY500 Válvula Schraeder (Standard si no se selecciona ninguna opción) Schraeder inner tube valve	<input type="checkbox"/> XY490 Válvula Presta Presta inner tube valve
---	--

Accesorios para ruedas

<input type="checkbox"/> XK220 Ejes quick release de titanio (par) (No compatibles con XK010 y XK070) (N/A with XK010 & XK070) Titanium 130mm quick release axle pins (pair) 182,49 €	<input type="checkbox"/> XK300 Ruedas Offroad 22" (sustituye a las ruedas 24" con cubiertas Kenda Alta Presión) Offroad wheel set 22" with handrim, MTB tyre and axle pins (Replaces 24" wheel with XM010) 1.038,58 €
<input type="checkbox"/> XK240 Desmontaje de ruedas para tetras (par) Quad release axle nuts (pair) 250 €	<input type="checkbox"/> XK310 Ruedas Offroad 24" (Sustituye a las ruedas 25" con cubiertas Kenda Alta Presión) Offroad wheel set 24" with handrim, MTB tyre and axle pins (Replaces 25" wheel with XM010) 1.038,58 €

COLORES ARMazón

Armazón y componentes

- | | | | | | | | | | | | | | | | | | | | | | | | | | | | | | | | | | | | | | | | | | | | | | | | | | | | | | | | | | | | | | | | | | | | | | | | | | | | | | | | | | | | | | | | | | | | | | | | | | | | | | | | | | | | | | | | | | | | | | | | | | | | | | | | | | | | | | | | | | | | | | | | | | | | | | | | | | | | | | | | | | | | | | | | | | | | | | | | | | | | | | | | | | | | | | | | | | |
|--|--|----------------------------|------------------|--------------------------|--------------------------|----------------------|-------------|--------------------------|--------------------------|-----------------------------|-----------------|----------------|--------------------------|--------------------------|---------------------|--|--------------------------|--------------------------|----------------|--|--------------------------|--------------------------|--------------------|--|--------------------------|--------------------------|----------------------|--|--------------------------|--------------------------|-----------------|--|--------------------------|--------------------------|-----------------------------|--|--------------------------|--------------------------|--------------------|--|--------------------------|--------------------------|---------------|--|--------------------------|--------------------------|---------------------------|--|--------------------------|--------------------------|---------------------|--|--------------------------|--------------------------|---------------------|--|--------------------------|--------------------------|--------------------------|--|--------------------------|--------------------------|--------------------|--|--------------------------|--------------------------|----------------------|--|--------------------------|--------------------------|---------------------|--|--------------------------|--------------------------|------------------------|--|--|--|--|--|--------------------------|--------------------------|-------------------|--|--------------------------|--------------------------|----------------------------|--|--|--|--|--|--------------------------|--------------------------|---------------------|--|--------------------------|--------------------------|---------------------|--|--|--|--|--|--|--|--|--|--------------------------|--------------------------|---------------------------|--|--|--|--|--|--|--|--|--|--------------------------|--------------------------|-------------------------|--|--|--|--|--|--|--|--|--|--------------------------|--------------------------|----------------------|--|--|--|--|--|--|--|--|--|--------------------------|--------------------------|------------------------|--|--|--|--|--|--|--|--|--|--------------------------|--------------------------|--------------------|--|--|--|--|--|--|--|--|--|--------------------------|--------------------------|-----------------------|--|--|--|--|--|--|--|--|--|--------------------------|--------------------------|----------------------|--|--|--|--|--|--|--|--|--|--|
| <input type="checkbox"/> XN010 Armazón pintado
Powder coated frame | <input type="checkbox"/> XN150 Acabado pintado de los componentes
(reposapiés, tubo del eje y protectores laterales)
(si no se especifica, mismo color que armazón)
Powder coated components (Frame colour if not specified) | | | | | | | | | | | | | | | | | | | | | | | | | | | | | | | | | | | | | | | | | | | | | | | | | | | | | | | | | | | | | | | | | | | | | | | | | | | | | | | | | | | | | | | | | | | | | | | | | | | | | | | | | | | | | | | | | | | | | | | | | | | | | | | | | | | | | | | | | | | | | | | | | | | | | | | | | | | | | | | | | | | | | | | | | | | | | | | | | | | | | | | | | | | | | | | | |
| <table border="0"> <tr> <td>Armazón</td> <td>Comp.</td> <td>Brillante</td> <td>Gloss</td> <td>Armazón</td> <td>Comp.</td> <td>Mate</td> <td>Matt</td> <td>Armazón</td> <td>Comp.</td> <td>Especial</td> <td>Special</td> </tr> <tr> <td><input type="checkbox"/></td> <td><input type="checkbox"/></td> <td>Negro brillante 103</td> <td></td> <td><input type="checkbox"/></td> <td><input type="checkbox"/></td> <td>Negro mate 105</td> <td></td> <td><input type="checkbox"/></td> <td><input type="checkbox"/></td> <td>Espejo cromado 300</td> <td></td> </tr> <tr> <td><input type="checkbox"/></td> <td><input type="checkbox"/></td> <td>Blanco brillante 100</td> <td></td> <td><input type="checkbox"/></td> <td><input type="checkbox"/></td> <td>Blanco mate 101</td> <td></td> <td><input type="checkbox"/></td> <td><input type="checkbox"/></td> <td>Gris plata c/ purpurina 170</td> <td></td> </tr> <tr> <td><input type="checkbox"/></td> <td><input type="checkbox"/></td> <td>Gris brillante 132</td> <td></td> <td><input type="checkbox"/></td> <td><input type="checkbox"/></td> <td>Gris mate 131</td> <td></td> <td><input type="checkbox"/></td> <td><input type="checkbox"/></td> <td>Negro mate metalizado 104</td> <td></td> </tr> <tr> <td><input type="checkbox"/></td> <td><input type="checkbox"/></td> <td>Crema brillante 135</td> <td></td> <td><input type="checkbox"/></td> <td><input type="checkbox"/></td> <td>Gris claro mate 133</td> <td></td> <td><input type="checkbox"/></td> <td><input type="checkbox"/></td> <td>Gris mate metalizado 130</td> <td></td> </tr> <tr> <td><input type="checkbox"/></td> <td><input type="checkbox"/></td> <td>Rojo brillante 108</td> <td></td> <td><input type="checkbox"/></td> <td><input type="checkbox"/></td> <td>Azul marino mate 152</td> <td></td> <td><input type="checkbox"/></td> <td><input type="checkbox"/></td> <td>Black sandpaper 201</td> <td></td> </tr> <tr> <td><input type="checkbox"/></td> <td><input type="checkbox"/></td> <td>Amarillo brillante 120</td> <td></td> <td></td> <td></td> <td></td> <td></td> <td><input type="checkbox"/></td> <td><input type="checkbox"/></td> <td>Gris jaspeado 202</td> <td></td> </tr> <tr> <td><input type="checkbox"/></td> <td><input type="checkbox"/></td> <td>Verde bosque brillante 143</td> <td></td> <td></td> <td></td> <td></td> <td></td> <td><input type="checkbox"/></td> <td><input type="checkbox"/></td> <td>Blanco jaspeado 200</td> <td></td> </tr> <tr> <td><input type="checkbox"/></td> <td><input type="checkbox"/></td> <td>Verde brillante 107</td> <td></td> <td></td> <td></td> <td></td> <td></td> <td></td> <td></td> <td></td> <td></td> </tr> <tr> <td><input type="checkbox"/></td> <td><input type="checkbox"/></td> <td>Azul oscuro brillante 151</td> <td></td> <td></td> <td></td> <td></td> <td></td> <td></td> <td></td> <td></td> <td></td> </tr> <tr> <td><input type="checkbox"/></td> <td><input type="checkbox"/></td> <td>Azul real brillante 154</td> <td></td> <td></td> <td></td> <td></td> <td></td> <td></td> <td></td> <td></td> <td></td> </tr> <tr> <td><input type="checkbox"/></td> <td><input type="checkbox"/></td> <td>Azulón brillante 174</td> <td></td> <td></td> <td></td> <td></td> <td></td> <td></td> <td></td> <td></td> <td></td> </tr> <tr> <td><input type="checkbox"/></td> <td><input type="checkbox"/></td> <td>Turquesa brillante 141</td> <td></td> <td></td> <td></td> <td></td> <td></td> <td></td> <td></td> <td></td> <td></td> </tr> <tr> <td><input type="checkbox"/></td> <td><input type="checkbox"/></td> <td>Rosa brillante 188</td> <td></td> <td></td> <td></td> <td></td> <td></td> <td></td> <td></td> <td></td> <td></td> </tr> <tr> <td><input type="checkbox"/></td> <td><input type="checkbox"/></td> <td>Naranja brillante 180</td> <td></td> <td></td> <td></td> <td></td> <td></td> <td></td> <td></td> <td></td> <td></td> </tr> <tr> <td><input type="checkbox"/></td> <td><input type="checkbox"/></td> <td>Morado brillante 157</td> <td></td> <td></td> <td></td> <td></td> <td></td> <td></td> <td></td> <td></td> <td></td> </tr> </table> | Armazón | Comp. | Brillante | Gloss | Armazón | Comp. | Mate | Matt | Armazón | Comp. | Especial | Special | <input type="checkbox"/> | <input type="checkbox"/> | Negro brillante 103 | | <input type="checkbox"/> | <input type="checkbox"/> | Negro mate 105 | | <input type="checkbox"/> | <input type="checkbox"/> | Espejo cromado 300 | | <input type="checkbox"/> | <input type="checkbox"/> | Blanco brillante 100 | | <input type="checkbox"/> | <input type="checkbox"/> | Blanco mate 101 | | <input type="checkbox"/> | <input type="checkbox"/> | Gris plata c/ purpurina 170 | | <input type="checkbox"/> | <input type="checkbox"/> | Gris brillante 132 | | <input type="checkbox"/> | <input type="checkbox"/> | Gris mate 131 | | <input type="checkbox"/> | <input type="checkbox"/> | Negro mate metalizado 104 | | <input type="checkbox"/> | <input type="checkbox"/> | Crema brillante 135 | | <input type="checkbox"/> | <input type="checkbox"/> | Gris claro mate 133 | | <input type="checkbox"/> | <input type="checkbox"/> | Gris mate metalizado 130 | | <input type="checkbox"/> | <input type="checkbox"/> | Rojo brillante 108 | | <input type="checkbox"/> | <input type="checkbox"/> | Azul marino mate 152 | | <input type="checkbox"/> | <input type="checkbox"/> | Black sandpaper 201 | | <input type="checkbox"/> | <input type="checkbox"/> | Amarillo brillante 120 | | | | | | <input type="checkbox"/> | <input type="checkbox"/> | Gris jaspeado 202 | | <input type="checkbox"/> | <input type="checkbox"/> | Verde bosque brillante 143 | | | | | | <input type="checkbox"/> | <input type="checkbox"/> | Blanco jaspeado 200 | | <input type="checkbox"/> | <input type="checkbox"/> | Verde brillante 107 | | | | | | | | | | <input type="checkbox"/> | <input type="checkbox"/> | Azul oscuro brillante 151 | | | | | | | | | | <input type="checkbox"/> | <input type="checkbox"/> | Azul real brillante 154 | | | | | | | | | | <input type="checkbox"/> | <input type="checkbox"/> | Azulón brillante 174 | | | | | | | | | | <input type="checkbox"/> | <input type="checkbox"/> | Turquesa brillante 141 | | | | | | | | | | <input type="checkbox"/> | <input type="checkbox"/> | Rosa brillante 188 | | | | | | | | | | <input type="checkbox"/> | <input type="checkbox"/> | Naranja brillante 180 | | | | | | | | | | <input type="checkbox"/> | <input type="checkbox"/> | Morado brillante 157 | | | | | | | | | | <input type="checkbox"/> XN200 Color personalizado
233,96 € Individual paint colour (State Colour/RAL code) <div style="border: 1px solid black; width: 100px; height: 40px; margin: 5px 0;"></div> <p>Armazón <input type="checkbox"/> Componentes <input type="checkbox"/></p> <p>NOTA: (ver guía de colores RGK)</p> |
| Armazón | Comp. | Brillante | Gloss | Armazón | Comp. | Mate | Matt | Armazón | Comp. | Especial | Special | | | | | | | | | | | | | | | | | | | | | | | | | | | | | | | | | | | | | | | | | | | | | | | | | | | | | | | | | | | | | | | | | | | | | | | | | | | | | | | | | | | | | | | | | | | | | | | | | | | | | | | | | | | | | | | | | | | | | | | | | | | | | | | | | | | | | | | | | | | | | | | | | | | | | | | | | | | | | | | | | | | | | | | | | | | | | | | | | | | | | | |
| <input type="checkbox"/> | <input type="checkbox"/> | Negro brillante 103 | | <input type="checkbox"/> | <input type="checkbox"/> | Negro mate 105 | | <input type="checkbox"/> | <input type="checkbox"/> | Espejo cromado 300 | | | | | | | | | | | | | | | | | | | | | | | | | | | | | | | | | | | | | | | | | | | | | | | | | | | | | | | | | | | | | | | | | | | | | | | | | | | | | | | | | | | | | | | | | | | | | | | | | | | | | | | | | | | | | | | | | | | | | | | | | | | | | | | | | | | | | | | | | | | | | | | | | | | | | | | | | | | | | | | | | | | | | | | | | | | | | | | | | | | | | | | |
| <input type="checkbox"/> | <input type="checkbox"/> | Blanco brillante 100 | | <input type="checkbox"/> | <input type="checkbox"/> | Blanco mate 101 | | <input type="checkbox"/> | <input type="checkbox"/> | Gris plata c/ purpurina 170 | | | | | | | | | | | | | | | | | | | | | | | | | | | | | | | | | | | | | | | | | | | | | | | | | | | | | | | | | | | | | | | | | | | | | | | | | | | | | | | | | | | | | | | | | | | | | | | | | | | | | | | | | | | | | | | | | | | | | | | | | | | | | | | | | | | | | | | | | | | | | | | | | | | | | | | | | | | | | | | | | | | | | | | | | | | | | | | | | | | | | | | |
| <input type="checkbox"/> | <input type="checkbox"/> | Gris brillante 132 | | <input type="checkbox"/> | <input type="checkbox"/> | Gris mate 131 | | <input type="checkbox"/> | <input type="checkbox"/> | Negro mate metalizado 104 | | | | | | | | | | | | | | | | | | | | | | | | | | | | | | | | | | | | | | | | | | | | | | | | | | | | | | | | | | | | | | | | | | | | | | | | | | | | | | | | | | | | | | | | | | | | | | | | | | | | | | | | | | | | | | | | | | | | | | | | | | | | | | | | | | | | | | | | | | | | | | | | | | | | | | | | | | | | | | | | | | | | | | | | | | | | | | | | | | | | | | | |
| <input type="checkbox"/> | <input type="checkbox"/> | Crema brillante 135 | | <input type="checkbox"/> | <input type="checkbox"/> | Gris claro mate 133 | | <input type="checkbox"/> | <input type="checkbox"/> | Gris mate metalizado 130 | | | | | | | | | | | | | | | | | | | | | | | | | | | | | | | | | | | | | | | | | | | | | | | | | | | | | | | | | | | | | | | | | | | | | | | | | | | | | | | | | | | | | | | | | | | | | | | | | | | | | | | | | | | | | | | | | | | | | | | | | | | | | | | | | | | | | | | | | | | | | | | | | | | | | | | | | | | | | | | | | | | | | | | | | | | | | | | | | | | | | | | |
| <input type="checkbox"/> | <input type="checkbox"/> | Rojo brillante 108 | | <input type="checkbox"/> | <input type="checkbox"/> | Azul marino mate 152 | | <input type="checkbox"/> | <input type="checkbox"/> | Black sandpaper 201 | | | | | | | | | | | | | | | | | | | | | | | | | | | | | | | | | | | | | | | | | | | | | | | | | | | | | | | | | | | | | | | | | | | | | | | | | | | | | | | | | | | | | | | | | | | | | | | | | | | | | | | | | | | | | | | | | | | | | | | | | | | | | | | | | | | | | | | | | | | | | | | | | | | | | | | | | | | | | | | | | | | | | | | | | | | | | | | | | | | | | | | |
| <input type="checkbox"/> | <input type="checkbox"/> | Amarillo brillante 120 | | | | | | <input type="checkbox"/> | <input type="checkbox"/> | Gris jaspeado 202 | | | | | | | | | | | | | | | | | | | | | | | | | | | | | | | | | | | | | | | | | | | | | | | | | | | | | | | | | | | | | | | | | | | | | | | | | | | | | | | | | | | | | | | | | | | | | | | | | | | | | | | | | | | | | | | | | | | | | | | | | | | | | | | | | | | | | | | | | | | | | | | | | | | | | | | | | | | | | | | | | | | | | | | | | | | | | | | | | | | | | | | |
| <input type="checkbox"/> | <input type="checkbox"/> | Verde bosque brillante 143 | | | | | | <input type="checkbox"/> | <input type="checkbox"/> | Blanco jaspeado 200 | | | | | | | | | | | | | | | | | | | | | | | | | | | | | | | | | | | | | | | | | | | | | | | | | | | | | | | | | | | | | | | | | | | | | | | | | | | | | | | | | | | | | | | | | | | | | | | | | | | | | | | | | | | | | | | | | | | | | | | | | | | | | | | | | | | | | | | | | | | | | | | | | | | | | | | | | | | | | | | | | | | | | | | | | | | | | | | | | | | | | | | |
| <input type="checkbox"/> | <input type="checkbox"/> | Verde brillante 107 | | | | | | | | | | | | | | | | | | | | | | | | | | | | | | | | | | | | | | | | | | | | | | | | | | | | | | | | | | | | | | | | | | | | | | | | | | | | | | | | | | | | | | | | | | | | | | | | | | | | | | | | | | | | | | | | | | | | | | | | | | | | | | | | | | | | | | | | | | | | | | | | | | | | | | | | | | | | | | | | | | | | | | | | | | | | | | | | | | | | | | | | | | | | | | | |
| <input type="checkbox"/> | <input type="checkbox"/> | Azul oscuro brillante 151 | | | | | | | | | | | | | | | | | | | | | | | | | | | | | | | | | | | | | | | | | | | | | | | | | | | | | | | | | | | | | | | | | | | | | | | | | | | | | | | | | | | | | | | | | | | | | | | | | | | | | | | | | | | | | | | | | | | | | | | | | | | | | | | | | | | | | | | | | | | | | | | | | | | | | | | | | | | | | | | | | | | | | | | | | | | | | | | | | | | | | | | | | | | | | | | |
| <input type="checkbox"/> | <input type="checkbox"/> | Azul real brillante 154 | | | | | | | | | | | | | | | | | | | | | | | | | | | | | | | | | | | | | | | | | | | | | | | | | | | | | | | | | | | | | | | | | | | | | | | | | | | | | | | | | | | | | | | | | | | | | | | | | | | | | | | | | | | | | | | | | | | | | | | | | | | | | | | | | | | | | | | | | | | | | | | | | | | | | | | | | | | | | | | | | | | | | | | | | | | | | | | | | | | | | | | | | | | | | | | |
| <input type="checkbox"/> | <input type="checkbox"/> | Azulón brillante 174 | | | | | | | | | | | | | | | | | | | | | | | | | | | | | | | | | | | | | | | | | | | | | | | | | | | | | | | | | | | | | | | | | | | | | | | | | | | | | | | | | | | | | | | | | | | | | | | | | | | | | | | | | | | | | | | | | | | | | | | | | | | | | | | | | | | | | | | | | | | | | | | | | | | | | | | | | | | | | | | | | | | | | | | | | | | | | | | | | | | | | | | | | | | | | | | |
| <input type="checkbox"/> | <input type="checkbox"/> | Turquesa brillante 141 | | | | | | | | | | | | | | | | | | | | | | | | | | | | | | | | | | | | | | | | | | | | | | | | | | | | | | | | | | | | | | | | | | | | | | | | | | | | | | | | | | | | | | | | | | | | | | | | | | | | | | | | | | | | | | | | | | | | | | | | | | | | | | | | | | | | | | | | | | | | | | | | | | | | | | | | | | | | | | | | | | | | | | | | | | | | | | | | | | | | | | | | | | | | | | | |
| <input type="checkbox"/> | <input type="checkbox"/> | Rosa brillante 188 | | | | | | | | | | | | | | | | | | | | | | | | | | | | | | | | | | | | | | | | | | | | | | | | | | | | | | | | | | | | | | | | | | | | | | | | | | | | | | | | | | | | | | | | | | | | | | | | | | | | | | | | | | | | | | | | | | | | | | | | | | | | | | | | | | | | | | | | | | | | | | | | | | | | | | | | | | | | | | | | | | | | | | | | | | | | | | | | | | | | | | | | | | | | | | | |
| <input type="checkbox"/> | <input type="checkbox"/> | Naranja brillante 180 | | | | | | | | | | | | | | | | | | | | | | | | | | | | | | | | | | | | | | | | | | | | | | | | | | | | | | | | | | | | | | | | | | | | | | | | | | | | | | | | | | | | | | | | | | | | | | | | | | | | | | | | | | | | | | | | | | | | | | | | | | | | | | | | | | | | | | | | | | | | | | | | | | | | | | | | | | | | | | | | | | | | | | | | | | | | | | | | | | | | | | | | | | | | | | | |
| <input type="checkbox"/> | <input type="checkbox"/> | Morado brillante 157 | | | | | | | | | | | | | | | | | | | | | | | | | | | | | | | | | | | | | | | | | | | | | | | | | | | | | | | | | | | | | | | | | | | | | | | | | | | | | | | | | | | | | | | | | | | | | | | | | | | | | | | | | | | | | | | | | | | | | | | | | | | | | | | | | | | | | | | | | | | | | | | | | | | | | | | | | | | | | | | | | | | | | | | | | | | | | | | | | | | | | | | | | | | | | | | |
| <input type="checkbox"/> TGAXN030 Acabado armazón Aluminio Mate
243,31 € (Resto de componentes en negro a menos que se seleccione XN160)
Brushed frame | <input type="checkbox"/> XN160 Acabado componentes Aluminio Mate
(reposapiés, tubo del eje y protectores laterales)
131,29 €
Brushed components | | | | | | | | | | | | | | | | | | | | | | | | | | | | | | | | | | | | | | | | | | | | | | | | | | | | | | | | | | | | | | | | | | | | | | | | | | | | | | | | | | | | | | | | | | | | | | | | | | | | | | | | | | | | | | | | | | | | | | | | | | | | | | | | | | | | | | | | | | | | | | | | | | | | | | | | | | | | | | | | | | | | | | | | | | | | | | | | | | | | | | | | | | | | | | | | |
| <input type="checkbox"/> TGAXN050 Acabado armazón Aluminio Brillo
760,38 € (Resto de componentes en negro a menos que se seleccione XN170)
Polished frame | <input type="checkbox"/> XN170 Acabado componentes Aluminio Brillo
(reposapiés, tubo del eje y protectores laterales)
261,86 €
Polished components | | | | | | | | | | | | | | | | | | | | | | | | | | | | | | | | | | | | | | | | | | | | | | | | | | | | | | | | | | | | | | | | | | | | | | | | | | | | | | | | | | | | | | | | | | | | | | | | | | | | | | | | | | | | | | | | | | | | | | | | | | | | | | | | | | | | | | | | | | | | | | | | | | | | | | | | | | | | | | | | | | | | | | | | | | | | | | | | | | | | | | | | | | | | | | | | |

Color anodizado en horquilla y detalles

Nota: Detalles de color en la horquilla y el armazón frontal.

- | | | |
|---|--|--|
| <input type="checkbox"/> Detalles en color negro
Black accent | <input type="checkbox"/> Detalles en color plata
Silver accent | <input type="checkbox"/> XN250 Detalles en color personalizado
209,95 €
Individual Accent Colour |
| <input type="checkbox"/> Detalles en color rojo
Red accent | <input type="checkbox"/> Detalles en color azul
Blue accent | <input style="width: 150px; height: 20px;" type="text"/> |
| <input type="checkbox"/> Detalles en color morado
Purple accent | <input type="checkbox"/> Detalles en carbono
(Sólo en armazón frontal, resto de detalles en negro)
Carbon accent (Castor caps only, black for rest) | |

TAPICERÍA

Tapicería de asiento

- | | |
|--|---|
| <input type="checkbox"/> XP040 Tapicería de asiento ajustable en tensión con cinchas
Seat sling adjustable tension with straps | <input type="checkbox"/> XR050 Base de asiento de fibra de carbono
543,06 € |
|--|---|

Tapicería de respaldo

- | | |
|--|--|
| <input type="checkbox"/> XP050 Tapicería de respaldo Air Tech ajustable en tensión con cinchas
AIRTECH | <input type="checkbox"/> XP070 Incremento tapicería con esquinas de cuero en negro
180,08 € (no posible con empuñaduras plegables XG080)
Backrest upgrade to leather corners (Black) |
|--|--|

Opciones de colores en costuras

- | | | | |
|---|---|--|---|
| <input type="checkbox"/> Plata
Silver | <input type="checkbox"/> Negro
Black | <input type="checkbox"/> Azul
Blue | <input type="checkbox"/> Color personalizado:
Individual: |
| <input type="checkbox"/> Rojo
Red | <input type="checkbox"/> Naranja
Orange | <input type="checkbox"/> Morado
Purple | <input style="width: 150px; height: 20px;" type="text"/> |

Color logo RGK

- | | | | |
|---|---|--|---|
| <input type="checkbox"/> Blanco (Std)
White (Std) | <input type="checkbox"/> Verde
Green | <input type="checkbox"/> Azul
Blue | <input type="checkbox"/> Color personalizado:
Individual: |
| <input type="checkbox"/> Rojo
Red | <input type="checkbox"/> Naranja
Orange | <input type="checkbox"/> Morado
Purple | <input style="width: 150px; height: 20px;" type="text"/> |

Color logo Tiga

- | | | | |
|---|---|--|---|
| <input type="checkbox"/> Blanco (Std)
White (Std) | <input type="checkbox"/> Verde
Green | <input type="checkbox"/> Azul
Blue | <input type="checkbox"/> Color personalizado:
Individual: |
| <input type="checkbox"/> Rojo
Red | <input type="checkbox"/> Naranja
Orange | <input type="checkbox"/> Morado
Purple | <input style="width: 150px; height: 20px;" type="text"/> |

Personalizaciones en tapicería

- | | | |
|---|--|------------------|
| <input type="checkbox"/> XP110 Tapicería de respaldo con bolsillo de cremallera
143,19 €
Backrest with zip pocket | <input type="checkbox"/> XP170 Tapicería con dibujo personalizado
219,57 € (Adjuntar Imagen JPG del diseño, y posición)
Individual backrest embroidery | <i>página 11</i> |
|---|--|------------------|

COJINES RGK

Cojín de espuma RGK

- XP080 Cojín espuma RGK (seleccionar funda abajo)
134.27 € (elegir densidad y altura del cojín)
Cushion foam (select density and size below)



- Cojín densidad blanda (CMS040)
Soft (CMS040)

- Cojín densidad media (CMS050)
Medium (CMS050)

- Altura cojín 50 mm
50mm

- Altura cojín 75 mm
75mm

- Altura cojín 100 mm
100mm

Opciones funda de cojín

- XP085 Funda de cojín de Nylon (color negro)
Nylon cushion cover (Black)
- XP090 Incremento funda de cojín Air Lite transpirable (color negro)
103.87 € Air Lite cushion cover (Black)
- XP100 Funda de cojín de cuero (color negro)
243.98 € Leather cushion cover (Black)

COJINES Y RESPALDOS JAY

Imprescindible adjuntar hoja de pedido del cojín o respaldo

- Cojines JAY
Consulta la gama completa y los precios en nuestra web.
JAY Cushion (Price dependant on size / option)
- Respaldos JAY
Consulta la gama completa y los precios en nuestra web.
JAY Backrest (Price dependant on size / option)

OPCIONES DE ARMAZÓN

- XR060 Anclajes para cincha pantorrillera integrados en el chasis
163.19 € (Para colocar la cincha pantorrillera en el armazón frontal)
Welded calf strap mounting loops
(To locate calf strap on front frame)

Especificar altura desde el suelo

- Medidas optimizadas
Optimise measurements

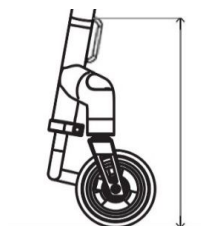

RUEDA FRONTAL TODOTERRENO

- XR080 Rueda frontal todoterreno Frontwheel (Sólo con reposapiés XB010, TGAXB080, XB150)
906.67 € Frontwheel assembly (Only with Tubular style footrest)

ACCESORIOS

- XP120 Protectores del chasis de neopreno con cremallera (color negro)
115.71 € Frame protectors Neoprene zip fasten (Black)
- XP420 Tectores del armazón de Nylon con velcro (color negro)
84.31 € Frame protectors Nylon velcro fasten (Black)
- XR010 Bolsa para objetos personales con Velcro sobre asiento (color negro)
60.82 € Seat pouch velcro attach (Black)
- XR200 Mochila negra con logo RGK
90.08 € Rucksack with RGK logo (Black)
- XR090 Kit de herramientas
Tool kit
- XS060 Cincha pantorrillera
Calf strap

NOTAS ADICIONALES

TAPICERÍA CON DIBUJO PERSONALIZADO (XP170)

ADJUNTAR IMAGEN JPG DEL DISEÑO E INDICAR POSICIÓN ABAJO



BARRA RIGIDIZADORA RESPALDO

NOTAS ADICIONALES SOBRE LA SILLA:

BUILT-4-ME

SOLICITUD DE ESPECIFICACIONES ESPECIALES *

(por favor detalla abajo en qué consiste la especificación especial y la(s) página(s) a las que aplica)

SOLICITUD DE ESPECIFICACIONES ESPECIALES APROBADA (Uso interno RGK)

Firma RGK

* Estas solicitudes especiales requieren un estudio de viabilidad que puede aumentar el precio y el plazo de entrega del pedido. Toda solicitud de dimensiones, opciones o armazón que no figure en la hoja de pedido se considerará una solicitud especial (Built-4-Me).